

National Testing Agency

Question Paper Name: Paper I EHG 9th Jan 2019 Shift 2
Subject Name: Paper I EHG
Creation Date: 2019-01-09 20:44:41
Duration: 180
Total Marks: 360
Display Marks: Yes

Paper I

Group Number : 1
Group Id : 416529112
Group Maximum Duration : 0
Group Minimum Duration : 180
Revisit allowed for view? : No
Revisit allowed for edit? : No
Break time: 0
Group Marks: 360

Physics

Section Id : 416529118
Section Number : 1
Section type : Online
Mandatory or Optional: Mandatory
Number of Questions: 30
Number of Questions to be attempted: 30
Section Marks: 120
Display Number Panel: Yes
Group All Questions: No

Sub-Section Number: 1
Sub-Section Id: 416529127
Question Shuffling Allowed : Yes

Question Number : 1 Question Type : MCQ Option Shuffling : Yes Display Question Number : Yes Single Line Question Option : No Option Orientation : Vertical

Correct Marks : 4 Wrong Marks : 1

Expression for time in terms of G (universal gravitational constant), h (Planck constant) and c (speed of light) is proportional to :

Options :

1. $\sqrt{\frac{Gh}{c^3}}$

2. $\sqrt{\frac{c^3}{Gh}}$

3. $\sqrt{\frac{Gh}{c^5}}$

4. $\sqrt{\frac{hc^5}{G}}$

Question Number : 1 Question Type : MCQ Option Shuffling : Yes Display Question Number : Yes Single Line Question Option : No Option Orientation : Vertical

Correct Marks : 4 Wrong Marks : 1

G (સાર્વત્રિક ગુરુત્વાકર્ષણ નિયતાંક), h (પ્લાંક નિયતાંક) તથા c (પ્રકાશ કી ગતિ) કે રૂપ મેં સમય કા સમતુલ્ય સંબંધ નિમ્ન મેં કિસકે સમાનુપાતી હોગા ?

Options :

1. $\sqrt{\frac{Gh}{c^3}}$

2. $\sqrt{\frac{c^3}{Gh}}$

3. $\sqrt{\frac{Gh}{c^5}}$

4. $\sqrt{\frac{hc^5}{G}}$

Question Number : 1 Question Type : MCQ Option Shuffling : Yes Display Question Number : Yes Single Line Question Option : No Option Orientation : Vertical

Correct Marks : 4 Wrong Marks : 1

G (ગુરુત્વાકર્ષણનો સાર્વત્રિક અચળાંક), h (પ્લાંકનો અચળાંક) અને c (પ્રકાશની ઝડપ) ના પદોમાં સમયની અભિવ્યક્તિ _____ ને થલે છે.

Options :

1. $\sqrt{\frac{Gh}{c^3}}$

2. $\sqrt{\frac{c^3}{Gh}}$

3. $\sqrt{\frac{Gh}{c^5}}$

4. $\sqrt{\frac{hc^5}{G}}$

Question Number : 2 Question Type : MCQ Option Shuffling : Yes Display Question Number : Yes Single Line Question Option : No Option Orientation : Vertical

Correct Marks : 4 Wrong Marks : 1

In a car race on straight road, car A takes a time t less than car B at the finish and passes finishing point with a speed ' v ' more than that of car B. Both the cars start from rest and travel with constant acceleration a_1 and a_2 respectively. Then ' v ' is equal to :

Options :

1. $\sqrt{2a_1a_2} t$

2. $\sqrt{a_1a_2} t$

3. $\frac{a_1 + a_2}{2} t$

4. $\frac{2a_1a_2}{a_1 + a_2} t$

Question Number : 2 Question Type : MCQ Option Shuffling : Yes Display Question Number : Yes Single Line Question Option : No Option Orientation : Vertical

Correct Marks : 4 Wrong Marks : 1

एक सीधी सड़क पर कारों की एक स्पर्धा में, कार 'A' को कार 'B' की अपेक्षा अंत तक पहुँचने में ' t ' समय कम लगता है तथा अन्त बिन्दु पर उसकी गति कार 'B' से v अधिक होती है। दोनों कारें स्थिरावस्था से नियत त्वरण a_1 तथा a_2 से चलती हैं। v का मान होगा :

Options :

1. $\sqrt{2a_1a_2} t$

2. $\sqrt{a_1a_2} t$

3. $\frac{a_1 + a_2}{2} t$

4. $\frac{2a_1a_2}{a_1 + a_2} t$

Question Number : 2 Question Type : MCQ Option Shuffling : Yes Display Question Number : Yes Single Line Question Option : No Option Orientation : Vertical

Correct Marks : 4 Wrong Marks : 1

સીધા રોડ પરની એક કાર રેસમાં કાર A એ અંતિમ રેખા સુધી t સમય લે છે જે કાર B કરતા ઓછો છે અને અંતિમ બિંદુ પર v ઝડપ ધરાવે છે જે કાર B કરતાં વધુ છે. આ બન્ને કાર સ્થિર સ્થિતિમાંથી શરૂ કરે છે અને ક્રમશઃ a_1 અને a_2 અચળ પ્રવેગથી ગતિ કરે છે તો v બરાબર :

Options :

1. $\sqrt{2a_1a_2} t$

2. $\sqrt{a_1a_2} t$

3. $\frac{a_1 + a_2}{2} t$

4. $\frac{2a_1a_2}{a_1 + a_2} t$

Question Number : 3 Question Type : MCQ Option Shuffling : Yes Display Question Number : Yes Single Line Question Option : No Option Orientation : Vertical

Correct Marks : 4 Wrong Marks : 1

The position co-ordinates of a particle moving in a 3-D coordinate system is given

by $x = a \cos \omega t$

$y = a \sin \omega t$

and $z = a \omega t$

The speed of the particle is :

Options :

1. $a\omega$
2. $2a\omega$
3. $\sqrt{2} a\omega$
4. $\sqrt{3} a\omega$

Question Number : 3 Question Type : MCQ Option Shuffling : Yes Display Question Number : Yes Single Line Question Option : No Option Orientation : Vertical

Correct Marks : 4 Wrong Marks : 1

एक त्रिविमीय निर्देशांक निकाय में गतिशील एक कण के स्थिति निर्देशांक निम्न हैं :

$$x = a \cos \omega t$$

$$y = a \sin \omega t$$

$$z = a\omega t$$

इस कण की गति का मान होगा :

- Options :
1. $a\omega$
 2. $2a\omega$
 3. $\sqrt{2} a\omega$
 4. $\sqrt{3} a\omega$

Question Number : 3 Question Type : MCQ Option Shuffling : Yes Display Question Number : Yes Single Line Question Option : No Option Orientation : Vertical

Correct Marks : 4 Wrong Marks : 1

त्रिपरिभाषीय યામોમાં ગતિ કરતાં એક કણનાં સ્થાન-યામોને

$$x = a \cos \omega t$$

$$y = a \sin \omega t$$

$$z = a\omega t$$

વડે આપવામાં આવે છે. તો આ કણની ઝડપ :

- Options :
1. $a\omega$

2. $2a\omega$

2.

3. $\sqrt{2} a\omega$

3.

4. $\sqrt{3} a\omega$

4.

Question Number : 4 Question Type : MCQ Option Shuffling : Yes Display Question Number : Yes Single Line Question Option : No Option Orientation : Vertical

Correct Marks : 4 Wrong Marks : 1

A mass of 10 kg is suspended vertically by a rope from the roof. When a horizontal force is applied on the rope at some point, the rope deviated at an angle of 45° at the roof point. If the suspended mass is at equilibrium, the magnitude of the force applied is ($g = 10 \text{ ms}^{-2}$)

Options :

1. 100 N

1.

2. 200 N

2.

3. 140 N

3.

4. 70 N

4.

Question Number : 4 Question Type : MCQ Option Shuffling : Yes Display Question Number : Yes Single Line Question Option : No Option Orientation : Vertical

Correct Marks : 4 Wrong Marks : 1

10 kg ના દ્રવ્યમાનને છત પરથી દોરડા વડે ઉર્ધ્વદિશામાં લટકાવવામાં આવેલ છે. આ દોરડાના કોઈ એક બિંદુ પર જ્યારે સમક્ષિતિજ બળ લગાડવામાં આવે છે ત્યારે છત પરના બિંદુથી આ દોરડું 45° વિચલન પામે છે. જો લટકાવેલ દ્રવ્યમાન સંતુલનમાં હોય તો આપાત બળનું માન થશે : ($g = 10 \text{ ms}^{-2}$ લો.)

Options :

1. 100 N

1.

2. 200 N

2.

3. 140 N

3.

4. 70 N

Question Number : 4 Question Type : MCQ Option Shuffling : Yes Display Question Number : Yes Single Line Question Option : No Option Orientation : Vertical

Correct Marks : 4 Wrong Marks : 1

छत से 10 kg के एक द्रव्यमान को एक रस्सी से ऊर्ध्वाधर लटकाया गया है। रस्सी के किसी बिन्दु पर एक क्षैतिज बल लगाने से रस्सी छत वाले बिन्दु पर 45° कोण से विचलित हो जाती है। यदि लटका हुआ द्रव्यमान साम्यावस्था में है तो लगाये गये बल का मान होगा : (दिया है : $g = 10 \text{ ms}^{-2}$)

Options :

1. 100 N

2.

2. 200 N

3.

3. 140 N

4.

4. 70 N

Question Number : 5 Question Type : MCQ Option Shuffling : Yes Display Question Number : Yes Single Line Question Option : No Option Orientation : Vertical

Correct Marks : 4 Wrong Marks : 1

A force acts on a 2 kg object so that its position is given as a function of time as $x = 3t^2 + 5$. What is the work done by this force in first 5 seconds ?

Options :

1. 950 J

2.

2. 900 J

3.

3. 875 J

4.

4. 850 J

Question Number : 5 Question Type : MCQ Option Shuffling : Yes Display Question Number : Yes Single Line Question Option : No Option Orientation : Vertical

Correct Marks : 4 Wrong Marks : 1

2 kg द्रव्यमान के एक पिण्ड पर एक बल लगाते हैं जिससे उसकी स्थिति का समय के साथ परिवर्तन $x = 3t^2 + 5$ है। इस बल द्वारा प्रथम 5 s में किया गया कार्य होगा :

Options :

1. 950 J
2. 900 J
3. 875 J
4. 850 J

Question Number : 5 Question Type : MCQ Option Shuffling : Yes Display Question Number : Yes Single Line Question Option : No Option Orientation : Vertical

Correct Marks : 4 Wrong Marks : 1

2 kg ના એક પદાર્થ પર એક બળ એવી રીતે લગાડવામાં આવે છે કે તેની સ્થિતિને સમય વિધેય $x = 3t^2 + 5$ વડે આપવામાં આવે છે. પ્રથમ 5 s માં આ બળ વડે થતું કાર્ય શું છે?

Options :

1. 950 J
2. 900 J
3. 875 J
4. 850 J

Question Number : 6 Question Type : MCQ Option Shuffling : Yes Display Question Number : Yes Single Line Question Option : No Option Orientation : Vertical

Correct Marks : 4 Wrong Marks : 1

A rod of length 50 cm is pivoted at one end. It is raised such that it makes an angle of 30° from the horizontal as shown and released from rest. Its angular speed when it passes through the horizontal (in rad s^{-1}) will be ($g = 10 \text{ ms}^{-2}$)

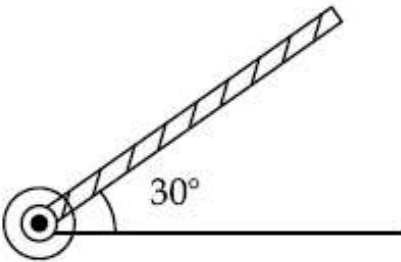

Options :

1. $\sqrt{30}$

2. $\sqrt{\frac{30}{2}}$

3. $\frac{\sqrt{30}}{2}$

4. $\frac{\sqrt{20}}{3}$

Question Number : 6 Question Type : MCQ Option Shuffling : Yes Display Question Number : Yes Single Line Question Option : No Option Orientation : Vertical

Correct Marks : 4 Wrong Marks : 1

50 cm की एक छड़ के एक सिरे को कीलकित किया है। इसको क्षैतिज से 30° कोण पर, चित्रानुसार, उठाकर स्थिरावस्था से छोड़ दिया जाता है। जब यह छड़ क्षैतिज अवस्था से गुजरती है तो इसकी कोणीय चाल का rad s^{-1} में मान होगा : (दिया है : $g = 10 \text{ ms}^{-2}$)

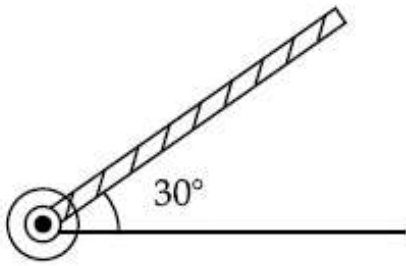

Options :

1. $\sqrt{30}$

2. $\sqrt{\frac{30}{2}}$

3. $\frac{\sqrt{30}}{2}$

4. $\frac{\sqrt{20}}{3}$

Question Number : 6 Question Type : MCQ Option Shuffling : Yes Display Question Number : Yes Single Line Question Option : No Option Orientation : Vertical

Correct Marks : 4 Wrong Marks : 1

50 cm લંબાઈના એક સળીયાને એક છેડાથી જડેલ છે. આ સળીયાને સમક્ષિતિથી 30° ના ખૂણે આકૃતિમાં બતાવ્યા પ્રમાણે ઊંચકીને સ્થિર અવસ્થામાંથી મુક્ત કરવામાં આવે છે. આ સળીયો જ્યારે સમક્ષિતિજને પસાર કરશે ત્યારે તેની કોણીય ઝડપ (rad s^{-1} માં) થશે : ($g = 10 \text{ ms}^{-2}$ લો.)

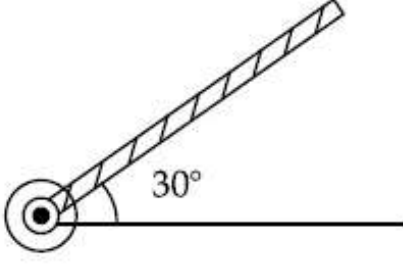

Options :

1. $\sqrt{30}$
2. $\sqrt{\frac{30}{2}}$
3. $\frac{\sqrt{30}}{2}$
4. $\frac{\sqrt{20}}{3}$

Question Number : 7 Question Type : MCQ Option Shuffling : Yes Display Question Number : Yes Single Line Question Option : No Option Orientation : Vertical

Correct Marks : 4 Wrong Marks : 1

A rod of mass ' M ' and length ' $2L$ ' is suspended at its middle by a wire. It exhibits torsional oscillations; If two masses each of ' m ' are attached at distance ' $L/2$ ' from its centre on both sides, it reduces the oscillation frequency by 20%. The value of ratio m/M is close to :

Options :

1. 0.17
2. 0.77
3. 0.57
4. 0.37

Question Number : 7 Question Type : MCQ Option Shuffling : Yes Display Question Number : Yes Single Line Question Option : No Option Orientation : Vertical

Correct Marks : 4 Wrong Marks : 1

द्रव्यमान 'M' तथा लम्बाई '2L' की एक छड़ को उसके मध्यबिन्दु से एक तार द्वारा लटकाया गया है। यह छड़ मरोड़ दोलन करती है। यदि प्रत्येक द्रव्यमान 'm' के दो पिण्डों को छड़ के मध्यबिन्दु से 'L/2' दूरी पर दोनों तरफ जोड़ते हैं, तो दोलन की आवृत्ति 20% घट जाती है। अनुपात m/M का सन्निकट मान होगा :

Options :

1. 0.17
2. 0.77
3. 0.57
4. 0.37

Question Number : 7 Question Type : MCQ Option Shuffling : Yes Display Question Number : Yes Single Line Question Option : No Option Orientation : Vertical

Correct Marks : 4 Wrong Marks : 1

'M' દ્રવ્યમાનનાં અને '2L' લંબાઈના એક સળિયાને તેના મધ્યમાંથી લટકાવેલ છે. તે ટોર્સનલ દોલનો કરે છે. 'm' દ્રવ્યમાનના એક એવા બે દ્રવ્યમાનોને સળિયાના મધ્યમાંથી 'L/2' અંતરે બન્ને બાજુ પર જોડવામાં આવતાં તે દોલનોની આવૃત્તિમાં 20% નો ઘટાડો કરે છે. m/M નું મૂલ્ય _____ ની નજીકનું છે.

Options :

1. 0.17
2. 0.77
3. 0.57
4. 0.37

Question Number : 8 Question Type : MCQ Option Shuffling : Yes Display Question Number : Yes Single Line Question Option : No Option Orientation : Vertical

Correct Marks : 4 Wrong Marks : 1

The energy required to take a satellite to a height 'h' above Earth surface (radius of Earth = 6.4×10^3 km) is E_1 and kinetic energy required for the satellite to be in a circular orbit at this height is E_2 . The value of h for which E_1 and E_2 are equal, is :

Options :

1. 1.28×10^4 km
2. 6.4×10^3 km
3. 1.6×10^3 km
4. 3.2×10^3 km

Question Number : 8 Question Type : MCQ Option Shuffling : Yes Display Question Number : Yes Single Line Question Option : No Option Orientation : Vertical

Correct Marks : 4 Wrong Marks : 1

एक उपग्रह को पृथ्वी की सतह से ऊँचाई h तक लाने में E_1 ऊर्जा लगती है तथा इस उपग्रह को इस ऊँचाई की वृत्ताकार कक्षा में रखने के लिए E_2 ऊर्जा की आवश्यकता होती है। h का वह मान, जिसके लिए E_1 तथा E_2 बराबर हैं, होगा :

(दिया है : पृथ्वी की त्रिज्या = 6.4×10^3 km)

Options :

1. 1.28×10^4 km
2. 6.4×10^3 km
3. 1.6×10^3 km
4. 3.2×10^3 km

Question Number : 8 Question Type : MCQ Option Shuffling : Yes Display Question Number : Yes Single Line Question Option : No Option Orientation : Vertical

Correct Marks : 4 Wrong Marks : 1

પૃથ્વીની સપાટીથી (પૃથ્વીની ત્રિજ્યા 6.4×10^3 km)

h ઊંચાઈ પર એક ઉપગ્રહને રાખવામાટેની જરૂરી ઊર્જા E_1 છે અને આ ઉપગ્રહને આ ઊંચાઈ પર વર્તુળાકાર કક્ષામાં રાખવા જરૂરી ગતિ ઊર્જા E_2 છે. E_1 અને E_2 સમાન થાય તેવી ઊંચાઈ h નું મૂલ્ય છે :

Options :

1. 1.28×10^4 km
2. 6.4×10^3 km
3. 1.6×10^3 km
4. 3.2×10^3 km

Question Number : 9 Question Type : MCQ Option Shuffling : Yes Display Question Number : Yes Single Line Question Option : No Option Orientation : Vertical

Correct Marks : 4 Wrong Marks : 1

The top of a water tank is open to air and its water level is maintained. It is giving out 0.74 m^3 water per minute through a circular opening of 2 cm radius in its wall. The depth of the centre of the opening from the level of water in the tank is close to :

Options :

1. 4.8 m
2. 9.6 m
3. 2.9 m
4. 6.0 m

Question Number : 9 Question Type : MCQ Option Shuffling : Yes Display Question Number : Yes Single Line Question Option : No Option Orientation : Vertical

Correct Marks : 4 Wrong Marks : 1

पानी की एक टंकी ऊपर से खुली हुयी है तथा इसमें पानी का स्तर स्थिर है। इसकी दीवार में उपस्थित एक 2 cm त्रिज्या के वृत्ताकार छेद से पानी $0.74 \text{ m}^3/\text{min}$. की दर से बह रहा है। इस छेद के केन्द्र की पानी की सतह से गहराई का सन्निकट मान होगा :

Options :

1. 4.8 m
2. 9.6 m
3. 2.9 m
4. 6.0 m

Question Number : 9 Question Type : MCQ Option Shuffling : Yes Display Question Number : Yes Single Line Question Option : No Option Orientation : Vertical

Correct Marks : 4 Wrong Marks : 1

એક ઊંચી પાણીની ટાંકીનો ઊપરનો ભાગ હવામાં ખુલ્લો છે અને તેનું પાણીનું સ્તર નગવર્ધ રહે છે. તેની દિવાલમાં 2 cm ની ત્રિજ્યાના ગોળાકાર કાણામાંથી બહાર 0.74 m^3 પાણી પ્રતિ મિનટ આપે છે. ટાંકીના પાણીના સ્તરથી આ કાણાના કેન્દ્રની ઊંડાઈ _____ ની નજીકની છે.

Options :

1. 4.8 m
2. 9.6 m
3. 2.9 m
4. 6.0 m

Question Number : 10 Question Type : MCQ Option Shuffling : Yes Display Question Number : Yes Single Line Question Option : No Option Orientation : Vertical

Correct Marks : 4 Wrong Marks : 1

Two Carnot engines A and B are operated in series. The first one, A, receives heat at $T_1 (= 600 \text{ K})$ and rejects to a reservoir at temperature T_2 . The second engine B receives heat rejected by the first engine and, in turn, rejects to a heat reservoir at $T_3 (= 400 \text{ K})$. Calculate the temperature T_2 if the work outputs of the two engines are equal :

Options :

1. 300 K
2. 400 K
3. 500 K
4. 600 K

Question Number : 10 Question Type : MCQ Option Shuffling : Yes Display Question Number : Yes Single Line Question Option : No Option Orientation : Vertical

Correct Marks : 4 Wrong Marks : 1

दो कार्नों (Carnot) इंजन A तथा B को श्रेणीक्रम में चलाया जाता है। पहला इंजन A तापमान $T_1 (= 600 \text{ K})$ पर ऊष्मा लेता है व तापमान T_2 के एक ऊष्मा भंडार को ऊष्मा देता है। दूसरा इंजन B इस पहले इंजन द्वारा दी हुयी ऊष्मा को लेकर तापमान $T_3 (= 400 \text{ K})$ के ऊष्मा भंडार को ऊष्मा देता है। यदि दोनों इंजनों का कार्य उत्पादन बराबर है तो T_2 का मान होगा :

Options :

1. 300 K
2. 400 K
3. 500 K
4. 600 K

Question Number : 10 Question Type : MCQ Option Shuffling : Yes Display Question Number : Yes Single Line Question Option : No Option Orientation : Vertical

Correct Marks : 4 Wrong Marks : 1

A અને B એમ બે કાર્નોટ એન્જિન શ્રેણીમાં કાર્યરત છે. પ્રથમ A, એ $T_1 (= 600 \text{ K})$ પર ઊષ્મા પ્રાપ્ત કરે છે અને તાપમાન T_2 સંગ્રાહક (પ્રાપ્તિ સ્થાન) તરફ છોડે છે. બીજું એન્જિન B એ પ્રથમ એન્જિન દ્વારા છોડેલ ઊષ્મા પ્રાપ્ત કરે છે અને $T_3 (= 400 \text{ K})$ પર ઊષ્મા સંગ્રાહક (પ્રાપ્તિ સ્થાન) તરફ છોડે છે. આ બન્ને એન્જિનના કાર્ય આઉટપુટ સરખા હોય ત્યારે તાપમાન T_2 હશે :

Options :

1. 300 K
2. 400 K
3. 500 K
4. 600 K

Question Number : 11 Question Type : MCQ Option Shuffling : Yes Display Question Number : Yes Single Line Question Option : No Option Orientation : Vertical

Correct Marks : 4 Wrong Marks : 1

A 15 g mass of nitrogen gas is enclosed in a vessel at a temperature 27°C . Amount of heat transferred to the gas, so that rms velocity of molecules is doubled, is about :

[Take $R = 8.3 \text{ J/K mole}$]

Options :

1. 0.9 kJ
2. 6 kJ
3. 10 kJ
4. 14 kJ

Question Number : 11 Question Type : MCQ Option Shuffling : Yes Display Question Number : Yes Single Line Question Option : No Option Orientation : Vertical

Correct Marks : 4 Wrong Marks : 1

નાઇટ્રોજન ગૈસ કી 15 g માત્રા કો એક પાત્ર મેં 27°C પર રખા હૈ। ઊષ્મા કી વહ માત્રા, જિસસે ગૈસ કે અણુઓં કા વર્ગ માધ્ય મૂલ વેગ દો ગુના હો જાયેગા, કા માન હોગા : (દિયા હૈ : $R = 8.3 \text{ J/K mole}$)

Options :

1. 0.9 kJ
2. 6 kJ
3. 10 kJ
4. 14 kJ

Question Number : 11 Question Type : MCQ Option Shuffling : Yes Display Question Number : Yes Single Line Question Option : No Option Orientation : Vertical

Correct Marks : 4 Wrong Marks : 1

27°C તાપમાને એક પાત્રમાં 15 g દ્રવ્યમાનના નાઇટ્રોજન વાયુને ભરેલ છે. આ વાયુઓની rms ઝડપ બમણી થાય તે માટે આ વાયુમાં તબદિલ ઊષ્માનો જથ્થો લગભગ _____ છે. ($R = 8.3 \text{ J/K mole}$ લો.)

Options :

1. 0.9 kJ
2. 6 kJ
3. 10 kJ

4. 14 kJ

Question Number : 12 Question Type : MCQ Option Shuffling : Yes Display Question Number : Yes Single Line Question Option : No Option Orientation : Vertical

Correct Marks : 4 Wrong Marks : 1

A musician using an open flute of length 50 cm produces second harmonic sound waves. A person runs towards the musician from another end of a hall at a speed of 10 km/h. If the wave speed is 330 m/s, the frequency heard by the running person shall be close to :

Options :

1. 333 Hz
2. 500 Hz
3. 666 Hz
4. 753 Hz

Question Number : 12 Question Type : MCQ Option Shuffling : Yes Display Question Number : Yes Single Line Question Option : No Option Orientation : Vertical

Correct Marks : 4 Wrong Marks : 1

50 cm लम्बाई की खुले सिरे की एक बाँसुरी से एक संगीतज्ञ द्वितीय सत्रादी ध्वनि तरंगें उत्पन्न करता है। एक व्यक्ति कक्ष के दूसरे सिरे से संगीतज्ञ की तरफ 10 km/h की गति से दौड़ता है। यदि ध्वनि की गति 330 m/s है तो दौड़ते हुये व्यक्ति द्वारा सुनी गयी आवृत्ति का सन्निकट मान होगा :

Options :

1. 333 Hz
2. 500 Hz
3. 666 Hz
4. 753 Hz

Question Number : 12 Question Type : MCQ Option Shuffling : Yes Display Question Number : Yes Single Line Question Option : No Option Orientation : Vertical

Correct Marks : 4 Wrong Marks : 1

50 cm લંબાઈની એક ખુલ્લી વાંસળીની મદદથી સંગીતકાર દ્વિતીય પ્રસંવાદી ધ્વનિ તરંગો ઉત્પન્ન કરે છે. ખંડના બીજા છેડા થી એક વ્યક્તિ 10 km/h ની ઝડપથી આ સંગીતકાર તરફ દોડે છે. જો તરંગની ઝડપ 330 m/s છે. તો દોડતી વ્યક્તિને સંભળાતી આવૃત્તિ _____ ની નજીકની હશે.

Options :

1. 333 Hz
2. 500 Hz
3. 666 Hz
4. 753 Hz

Question Number : 13 Question Type : MCQ Option Shuffling : Yes Display Question Number : Yes Single Line Question Option : No Option Orientation : Vertical

Correct Marks : 4 Wrong Marks : 1

A particle is executing simple harmonic motion (SHM) of amplitude A , along the x -axis, about $x=0$. When its potential Energy (PE) equals kinetic energy (KE), the position of the particle will be :

Options :

1. A
2. $\frac{A}{2}$
3. $\frac{A}{\sqrt{2}}$
4. $\frac{A}{2\sqrt{2}}$

Question Number : 13 Question Type : MCQ Option Shuffling : Yes Display Question Number : Yes Single Line Question Option : No Option Orientation : Vertical

Correct Marks : 4 Wrong Marks : 1

एक कण x -अक्ष की दिशा में, $x=0$ के सापेक्ष आयाम A से सरल आवर्त गति कर रहा है। जब इस कण की स्थितिज ऊर्जा तथा गतिज ऊर्जा के मान बराबर हैं, तो कण की स्थिति होगी :

Options :

1. A

2. $\frac{A}{2}$

3. $\frac{A}{\sqrt{2}}$

4. $\frac{A}{2\sqrt{2}}$

Question Number : 13 Question Type : MCQ Option Shuffling : Yes Display Question Number : Yes Single Line Question Option : No Option Orientation : Vertical

Correct Marks : 4 Wrong Marks : 1

એક કણ x -અક્ષ, $x = 0$ કે સાપેક્ષ તરફ A કંપવિસ્તારની સરળ આવર્ત ગતિ (સઆગ) કરે છે. જ્યારે તેની સ્થિતિ ઊર્જા (PE) એ ગતિઊર્જા (KE) ની બરાબર થાય ત્યારે આ કણની સ્થિતિ હશે :

Options :

1. A

2. $\frac{A}{2}$

3. $\frac{A}{\sqrt{2}}$

4. $\frac{A}{2\sqrt{2}}$

Question Number : 14 Question Type : MCQ Option Shuffling : Yes Display Question Number : Yes Single Line Question Option : No Option Orientation : Vertical

Correct Marks : 4 Wrong Marks : 1

A parallel plate capacitor with square plates is filled with four dielectrics of dielectric constants K_1, K_2, K_3, K_4 arranged as shown in the figure. The effective dielectric constant K will be :

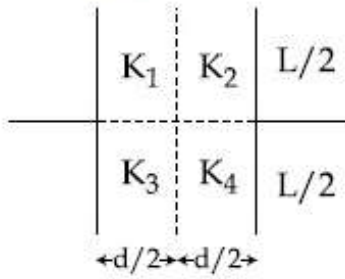

Options :

1.
$$K = \frac{(K_1 + K_2)(K_3 + K_4)}{K_1 + K_2 + K_3 + K_4}$$

2.
$$K = \frac{(K_1 + K_3)(K_2 + K_4)}{K_1 + K_2 + K_3 + K_4}$$

3.
$$K = \frac{(K_1 + K_4)(K_2 + K_3)}{2(K_1 + K_2 + K_3 + K_4)}$$

4.
$$K = \frac{(K_1 + K_2)(K_3 + K_4)}{2(K_1 + K_2 + K_3 + K_4)}$$

Question Number : 14 Question Type : MCQ Option Shuffling : Yes Display Question Number : Yes Single Line Question Option : No Option Orientation : Vertical

Correct Marks : 4 Wrong Marks : 1

वर्गाकार प्लेटों वाले एक समान्तर प्लेट संधारित्र को चित्रानुसार चार परावैद्युतों, जिनके परावैद्युतांक K_1, K_2, K_3 तथा K_4 हैं, से भर दिया जाता है तो प्रभावी परावैद्युतांक K का मान होगा :

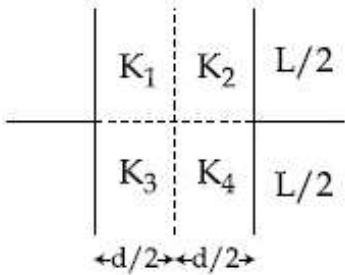

Options :

1.
$$K = \frac{(K_1 + K_2)(K_3 + K_4)}{K_1 + K_2 + K_3 + K_4}$$

2.
$$K = \frac{(K_1 + K_3)(K_2 + K_4)}{K_1 + K_2 + K_3 + K_4}$$

3.
$$K = \frac{(K_1 + K_4)(K_2 + K_3)}{2(K_1 + K_2 + K_3 + K_4)}$$

4.
$$K = \frac{(K_1 + K_2)(K_3 + K_4)}{2(K_1 + K_2 + K_3 + K_4)}$$

Question Number : 14 Question Type : MCQ Option Shuffling : Yes Display Question Number : Yes Single Line Question Option : No Option Orientation : Vertical Correct Marks : 4 Wrong Marks : 1

ચોરસ પ્લેટના એક સમાંતર પ્લેટ કેપેસિટરને ચાર પરાવૈદ્યુત દ્રવ્ય કે જેમના પરાવૈદ્યુતાંક K_1, K_2, K_3, K_4 છે. તેમનાથી આકૃતિમાં દર્શાવ્યા પ્રમાણે ભરેલ છે. અસરકારક પરાવૈદ્યુતાંક K _____ હશે.

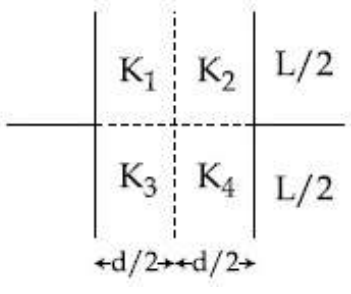

Options :

1.
$$K = \frac{(K_1 + K_2)(K_3 + K_4)}{K_1 + K_2 + K_3 + K_4}$$

2.
$$K = \frac{(K_1 + K_3)(K_2 + K_4)}{K_1 + K_2 + K_3 + K_4}$$

3.
$$K = \frac{(K_1 + K_4)(K_2 + K_3)}{2(K_1 + K_2 + K_3 + K_4)}$$

4.
$$K = \frac{(K_1 + K_2)(K_3 + K_4)}{2(K_1 + K_2 + K_3 + K_4)}$$

Question Number : 15 Question Type : MCQ Option Shuffling : Yes Display Question Number : Yes Single Line Question Option : No Option Orientation : Vertical Correct Marks : 4 Wrong Marks : 1

त्रिज्या R के एक गोले पर आवेश वितरित हैं जिसका

आयतनिक आवेश घनत्व $\rho(r) = \frac{A}{r^2} e^{-2r/a}$ से दिया जाता

है, जहाँ A तथा a नियतांक हैं। यदि इस आवेश वितरण का कुल आवेश Q है, तब त्रिज्या R का मान है :

Options :

1. $\frac{a}{2} \log \left(1 - \frac{Q}{2\pi a A} \right)$

2. $\frac{a}{2} \log \left(\frac{1}{1 - \frac{Q}{2\pi a A}} \right)$

3. $a \log \left(1 - \frac{Q}{2\pi a A} \right)$

4. $a \log \left(\frac{1}{1 - \frac{Q}{2\pi a A}} \right)$

Question Number : 15 Question Type : MCQ Option Shuffling : Yes Display Question Number : Yes Single Line Question Option : No Option Orientation : Vertical

Correct Marks : 4 Wrong Marks : 1

$\rho(r) = \frac{A}{r^2} e^{-2r/a}$; જ્યાં A અને a અચળાંકો છે, જેટલી

કદ વિદ્યુતભાર ઘનતા ધરાવતા R ત્રિજ્યાના ગોળામાં વિદ્યુત ભારનું વિતરણ થયેલ છે. જો Q એ આ વિતરણનો કુલ વિદ્યુતભાર હોય તો ત્રિજ્યા R હશે :

Options :

1. $\frac{a}{2} \log \left(1 - \frac{Q}{2\pi a A} \right)$

2. $\frac{a}{2} \log \left(\frac{1}{1 - \frac{Q}{2\pi a A}} \right)$

3. $a \log \left(1 - \frac{Q}{2\pi a A} \right)$

4. $a \log \left(\frac{1}{1 - \frac{Q}{2\pi a A}} \right)$

Question Number : 15 Question Type : MCQ Option Shuffling : Yes Display Question Number : Yes Single Line Question Option : No Option Orientation : Vertical

Correct Marks : 4 Wrong Marks : 1

Charge is distributed within a sphere of radius R with a volume charge density

$$\rho(r) = \frac{A}{r^2} e^{-2r/a}, \text{ where } A \text{ and } a \text{ are constants.}$$

If Q is the total charge of this charge distribution, the radius R is :

Options :

1. $\frac{a}{2} \log \left(1 - \frac{Q}{2\pi a A} \right)$

2. $\frac{a}{2} \log \left(\frac{1}{1 - \frac{Q}{2\pi a A}} \right)$

3. $a \log \left(1 - \frac{Q}{2\pi a A} \right)$

4. $a \log \left(\frac{1}{1 - \frac{Q}{2\pi a A}} \right)$

Question Number : 16 Question Type : MCQ Option Shuffling : Yes Display Question Number : Yes Single Line Question Option : No Option Orientation : Vertical

Correct Marks : 4 Wrong Marks : 1

Two point charges $q_1(\sqrt{10} \mu\text{C})$ and $q_2(-25 \mu\text{C})$ are placed on the x -axis at $x=1 \text{ m}$ and $x=4 \text{ m}$ respectively. The electric field (in V/m) at a point $y=3 \text{ m}$ on y -axis is,

$$\left[\text{take } \frac{1}{4\pi\epsilon_0} = 9 \times 10^9 \text{ Nm}^2\text{C}^{-2} \right]$$

Options :

1. $(-63 \hat{i} + 27 \hat{j}) \times 10^2$
2. $(63 \hat{i} - 27 \hat{j}) \times 10^2$
3. $(81 \hat{i} - 81 \hat{j}) \times 10^2$
4. $(-81 \hat{i} + 81 \hat{j}) \times 10^2$

Question Number : 16 Question Type : MCQ Option Shuffling : Yes Display Question Number : Yes Single Line Question Option : No Option Orientation : Vertical

Correct Marks : 4 Wrong Marks : 1

दो बिन्दु आवेशों $q_1(\sqrt{10} \mu\text{C})$ तथा $q_2(-25 \mu\text{C})$ को x -अक्ष पर क्रमशः $x=1 \text{ m}$ तथा $x=4 \text{ m}$ पर रखा गया है। y -अक्ष पर बिन्दु $y=3 \text{ m}$ पर विद्युत क्षेत्र का मान (V/m में) होगा :

$$\left[\text{दिया है: } \frac{1}{4\pi\epsilon_0} = 9 \times 10^9 \text{ Nm}^2\text{C}^{-2} \right]$$

Options :

1. $(-63 \hat{i} + 27 \hat{j}) \times 10^2$
2. $(63 \hat{i} - 27 \hat{j}) \times 10^2$
3. $(81 \hat{i} - 81 \hat{j}) \times 10^2$
4. $(-81 \hat{i} + 81 \hat{j}) \times 10^2$

Question Number : 16 Question Type : MCQ Option Shuffling : Yes Display Question Number : Yes Single Line Question Option : No Option Orientation : Vertical

Correct Marks : 4 Wrong Marks : 1

બે બિંદુવત વિજભારો $q_1(\sqrt{10} \mu\text{C})$ અને $q_2(-25 \mu\text{C})$ ને x - અક્ષ પર અનુક્રમે $x=1 \text{ m}$ અને $x=4 \text{ m}$ પર મુકેલ છે. y - અક્ષ પરના $y=3 \text{ m}$ પર વિદ્યુત ક્ષેત્રનું મૂલ્ય (V/m માં) હશે :

$$\left[\frac{1}{4\pi\epsilon_0} = 9 \times 10^9 \text{ Nm}^2\text{C}^{-2} \right]$$

Options :

1. $(-63 \hat{i} + 27 \hat{j}) \times 10^2$
2. $(63 \hat{i} - 27 \hat{j}) \times 10^2$
3. $(81 \hat{i} - 81 \hat{j}) \times 10^2$
4. $(-81 \hat{i} + 81 \hat{j}) \times 10^2$

Question Number : 17 Question Type : MCQ Option Shuffling : Yes Display Question Number : Yes Single Line Question Option : No Option Orientation : Vertical

Correct Marks : 4 Wrong Marks : 1

In the given circuit the internal resistance of the 18 V cell is negligible. If $R_1 = 400 \Omega$, $R_3 = 100 \Omega$ and $R_4 = 500 \Omega$ and the reading of an ideal voltmeter across R_4 is 5 V, then the value of R_2 will be :

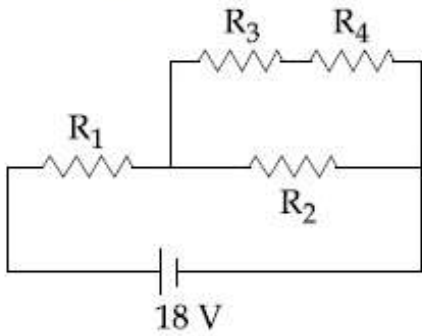

Options :

1. 550 Ω
2. 230 Ω
3. 450 Ω
4. 300 Ω

Question Number : 17 Question Type : MCQ Option Shuffling : Yes Display Question Number : Yes Single Line Question Option : No Option Orientation : Vertical

Correct Marks : 4 Wrong Marks : 1

दिये गये परिपथ में 18 V की सेल का आंतरिक प्रतिरोध नगण्य है। यदि $R_1 = 400 \Omega$, $R_3 = 100 \Omega$ तथा $R_4 = 500 \Omega$, हैं और R_4 पर लगे एक आदर्श वोल्टमीटर का पाठ्यांक 5 V है, तो R_2 का मान होगा :

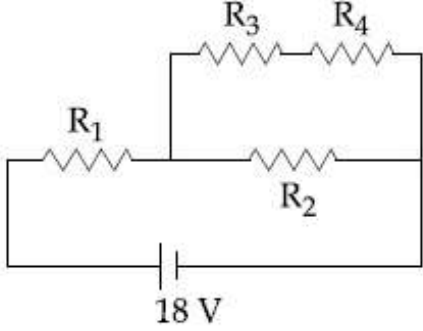

Options :

1. 550 Ω
2. 230 Ω
3. 450 Ω
4. 300 Ω

Question Number : 17 Question Type : MCQ Option Shuffling : Yes Display Question Number : Yes Single Line Question Option : No Option Orientation : Vertical

Correct Marks : 4 Wrong Marks : 1

આપેલ પરિપથમાં 18 V કોષનો આંતરિક અવરોધ અવગણ્ય છે. જો $R_1 = 400 \Omega$, $R_3 = 100 \Omega$ અને $R_4 = 500 \Omega$, અને જો R_4 ની સાપેક્ષે આદર્શ વોલ્ટમીટરનું વાંચન 5 V છે, તો R_2 નું મૂલ્ય હશે :

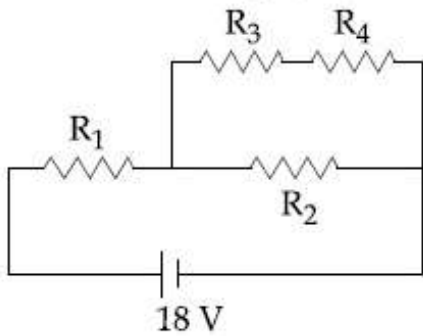

Options :

1. 550 Ω
2. 230 Ω

3. 450Ω

4. 300Ω

Question Number : 18 Question Type : MCQ Option Shuffling : Yes Display Question Number : Yes Single Line Question Option : No Option Orientation : Vertical

Correct Marks : 4 Wrong Marks : 1

A series AC circuit containing an inductor (20 mH), a capacitor (120 μ F) and a resistor (60 Ω) is driven by an AC source of 24 V/50 Hz. The energy dissipated in the circuit in 60 s is :

Options :

1. 5.65×10^2 J

2. 2.26×10^3 J

3. 5.17×10^2 J

4. 3.39×10^3 J

Question Number : 18 Question Type : MCQ Option Shuffling : Yes Display Question Number : Yes Single Line Question Option : No Option Orientation : Vertical

Correct Marks : 4 Wrong Marks : 1

एक श्रेणीबद्ध प्रत्यावर्ती परिपथ में एक प्रेरक (20 mH), एक संधारित्र (120 μ F) तथा एक प्रतिरोध (60 Ω) लगे हैं और यह एक 24 V/50 Hz के प्रत्यावर्ती स्रोत से चालित है। 60 s समय में क्षयित ऊर्जा का मान होगा :

Options :

1. 5.65×10^2 J

2. 2.26×10^3 J

3. 5.17×10^2 J

4. 3.39×10^3 J

Question Number : 18 Question Type : MCQ Option Shuffling : Yes Display Question Number : Yes Single Line Question Option : No Option Orientation : Vertical

Correct Marks : 4 Wrong Marks : 1

એક ઇન્ડક્ટર (20 mH), એક કેપેસિટર (120 μ F) અને અવરોધ (60 Ω) ધરાવતા એક શ્રેણી AC પરિપથ એ એક 24 V/50 Hz ના AC ઉદ્ગમથી ચાલીત છે. આ પરિપથમાં 60 s થતો ઊર્જાનો વ્યય _____ છે.

Options :

1. 5.65×10^2 J
2. 2.26×10^3 J
3. 5.17×10^2 J
4. 3.39×10^3 J

Question Number : 19 Question Type : MCQ Option Shuffling : Yes Display Question Number : Yes Single Line Question Option : No Option Orientation : Vertical

Correct Marks : 4 Wrong Marks : 1

લમ્બાઈ L કે દો એકસમાન ચાલક તારોં મેં સે એક કો વૃત્તાકાર વલય કી આકૃતિ મેં લાયા જાતા હૈ તથા દૂસરે કો N એકસમાન ફેરોં કી વૃત્તાકાર કુંડલી મેં મોડા જાતા હૈ। યદિ દોનોં સે એક હી ધારા પ્રવાહિત કી જાતી હૈ, તો વલય તથા કુંડલી કે કેન્દ્રોં પર ઉપસ્થિત ચુમ્બકીય

ક્ષેત્ર, ક્રમશઃ B_L તથા B_C હોં, તબ અનુપાત $\frac{B_L}{B_C}$

હોગા :

Options :

1. N
2. N^2
3. $\frac{1}{N^2}$
4. $\frac{1}{N}$

Question Number : 19 Question Type : MCQ Option Shuffling : Yes Display Question Number : Yes Single Line Question Option : No Option Orientation : Vertical

Correct Marks : 4 Wrong Marks : 1

L જેટલી સમાન લંબાઈના બે વાહક તારમાંથી એકને વાળીને વર્તુળાકાર બંધગાળો બનાવવામાં આવે છે અને બીજાને N સમાન આંટાઓવાળું ગુંચળું બનાવવામાં આવે છે. જો બન્નેમાં સમાન પ્રવાહ પસાર કરાવામાં આવે તો બંધગાળાના કેન્દ્રના ચુંબકીય ક્ષેત્ર (B_L) અને ગુંચળાના

કેન્દ્રનાં ચુંબકીય ક્ષેત્ર (B_C) નો ગુણોત્તર $\frac{B_L}{B_C}$ એ

_____ થશે.

Options :

1. N
2. N^2
3. $\frac{1}{N^2}$
4. $\frac{1}{N}$

Question Number : 19 Question Type : MCQ Option Shuffling : Yes Display Question Number : Yes Single Line Question Option : No Option Orientation : Vertical

Correct Marks : 4 Wrong Marks : 1

One of the two identical conducting wires of length L is bent in the form of a circular loop and the other one into a circular coil of N identical turns. If the same current is passed in both, the ratio of the magnetic field at the central of the loop (B_L) to that at

the centre of the coil (B_C), i.e. $\frac{B_L}{B_C}$ will be :

Options :

1. N
2. N^2
3. $\frac{1}{N^2}$
4. $\frac{1}{N}$

Question Number : 20 Question Type : MCQ Option Shuffling : Yes Display Question Number : Yes Single Line Question Option : No Option Orientation : Vertical

Correct Marks : 4 Wrong Marks : 1

A particle having the same charge as of electron moves in a circular path of radius 0.5 cm under the influence of a magnetic field of 0.5 T. If an electric field of 100 V/m makes it to move in a straight path, then the mass of the particle is (Given charge of electron = $1.6 \times 10^{-19} \text{C}$)

Options :

1. $9.1 \times 10^{-31} \text{ kg}$
2. $2.0 \times 10^{-24} \text{ kg}$
3. $1.6 \times 10^{-19} \text{ kg}$
4. $1.6 \times 10^{-27} \text{ kg}$

Question Number : 20 Question Type : MCQ Option Shuffling : Yes Display Question Number : Yes Single Line Question Option : No Option Orientation : Vertical

Correct Marks : 4 Wrong Marks : 1

एक कण, जिसका आवेश इलेक्ट्रॉन के आवेश के समान है, 0.5 T चुम्बकीय क्षेत्र में एक 0.5 cm त्रिज्या के वृत्ताकार पथ पर चलता है। यदि 100 V/m का विद्युत क्षेत्र लगाने पर यह कण एक सीधी रेखा में चलता है, तो कण का द्रव्यमान होगा :
(दिया है इलेक्ट्रॉन का आवेश = $1.6 \times 10^{-19} \text{C}$)

Options :

1. $9.1 \times 10^{-31} \text{ kg}$
2. $2.0 \times 10^{-24} \text{ kg}$
3. $1.6 \times 10^{-19} \text{ kg}$
4. $1.6 \times 10^{-27} \text{ kg}$

Question Number : 20 Question Type : MCQ Option Shuffling : Yes Display Question Number : Yes Single Line Question Option : No Option Orientation : Vertical

Correct Marks : 4 Wrong Marks : 1

इलेक्ट्रॉनना बेटलोब वीजभार धरावतो अक कण 0.5 cm त्रिज्याना वर्तुणाकार पथपर 0.5 T चुंबकीय क्षेत्रनी असर नीचे गति करे छे. जे 100 V/m नुं विद्युत क्षेत्र तेने सुरेभ पथपर गति करावे, तो आ कणनुं द्रव्यमान हरो :
(इलेक्ट्रॉननो विजभार = $1.6 \times 10^{-19} \text{C}$)

Options :

1. 9.1×10^{-31} kg
2. 2.0×10^{-24} kg
3. 1.6×10^{-19} kg
4. 1.6×10^{-27} kg

Question Number : 21 Question Type : MCQ Option Shuffling : Yes Display Question Number : Yes Single Line Question Option : No Option Orientation : Vertical

Correct Marks : 4 Wrong Marks : 1

A power transmission line feeds input power at 2300 V to a step down transformer with its primary windings having 4000 turns. The output power is delivered at 230 V by the transformer. If the current in the primary of the transformer is 5A and its efficiency is 90%, the output current would be :

Options :

1. 35 A
2. 50 A
3. 45 A
4. 25 A

Question Number : 21 Question Type : MCQ Option Shuffling : Yes Display Question Number : Yes Single Line Question Option : No Option Orientation : Vertical

Correct Marks : 4 Wrong Marks : 1

2300 V की एक शक्ति संचरण लाइन एक अपचायी ट्रांसफॉर्मर, जिसके प्राथमिक कुंडली में 4000 फेरें हैं, को शक्ति प्रदान करती है। ट्रांसफॉर्मर 230 V के निर्गत विभव पर शक्ति वितरण करता है। यदि ट्रांसफॉर्मर की प्राथमिक कुंडली में 5A की धारा है तथा इसकी दक्षता 90% है, तो निर्गत धारा का मान होगा :

Options :

1. 35 A
2. 50 A

3. 45 A

4. 25 A

Question Number : 21 Question Type : MCQ Option Shuffling : Yes Display Question Number : Yes Single Line Question Option : No Option Orientation : Vertical

Correct Marks : 4 Wrong Marks : 1

એક પાવર ટ્રાન્સમીશન લાઇન એ 2300 V નો પાવર એક સ્ટેપ ડાઉન ટ્રાન્સફોર્મર કે જેનું મુખ્ય ગુંચળું 4000 આંટાઓ ધરાવે છે તેને આપવામાં આવે છે. આ ટ્રાન્સફોર્મર વડે 230 V પાવર ડિલિવર કરવામાં આવે છે. જો આ ટ્રાન્સફોર્મરનાં મુખ્ય ગુંચળામાં 5A પ્રવાહ અને કાર્યક્ષમતા 90% છે તો આઉટપૂટ પ્રવાહ હશે :

Options :

1. 35 A

2. 50 A

3. 45 A

4. 25 A

Question Number : 22 Question Type : MCQ Option Shuffling : Yes Display Question Number : Yes Single Line Question Option : No Option Orientation : Vertical

Correct Marks : 4 Wrong Marks : 1

The energy associated with electric field is (U_E) and with magnetic field is (U_B) for an electromagnetic wave in free space. Then :

Options :

1. $U_E > U_B$

2. $U_E < U_B$

3. $U_E = U_B$

4. $U_E = \frac{U_B}{2}$

Question Number : 22 Question Type : MCQ Option Shuffling : Yes Display Question Number : Yes Single Line Question Option : No Option Orientation : Vertical

Correct Marks : 4 Wrong Marks : 1

यदि मुक्त आकाश में एक विद्युत चुम्बकीय तरंग के विद्युत क्षेत्र में निहित ऊर्जा (U_E) तथा चुम्बकीय क्षेत्र में निहित ऊर्जा (U_B) है, तो :

Options :

1. $U_E > U_B$

2. $U_E < U_B$

3. $U_E = U_B$

4. $U_E = \frac{U_B}{2}$

Question Number : 22 Question Type : MCQ Option Shuffling : Yes Display Question Number : Yes Single Line Question Option : No Option Orientation : Vertical

Correct Marks : 4 Wrong Marks : 1

मुक्त अवकाशमा विद्युतचुम्बकीय तरंगमाटे जे (U_E) अने (U_B) जे क्रमशः विद्युतक्षेत्र अने चुम्बकीय क्षेत्र साथे संकणायेल उर्जा छे, तो :

Options :

1. $U_E > U_B$

2. $U_E < U_B$

3. $U_E = U_B$

4. $U_E = \frac{U_B}{2}$

Question Number : 23 Question Type : MCQ Option Shuffling : Yes Display Question Number : Yes Single Line Question Option : No Option Orientation : Vertical

Correct Marks : 4 Wrong Marks : 1

Two plane mirrors are inclined to each other such that a ray of light incident on the first mirror (M_1) and parallel to the second mirror (M_2) is finally reflected from the second mirror (M_2) parallel to the first mirror (M_1). The angle between the two mirrors will be :

Options :

1. 45°

2. 60°
3. 75°
4. 90°

Question Number : 23 Question Type : MCQ Option Shuffling : Yes Display Question Number : Yes Single Line Question Option : No Option Orientation : Vertical

Correct Marks : 4 Wrong Marks : 1

दो समतल दर्पणों (M_1 तथा M_2) को परस्पर ऐसे कोण पर रखा गया है जिससे प्रकाश की एक किरण जब M_2 के समांतर जाती हुयी M_1 पर आपतित होती है तो अंततः वह M_2 से M_1 के समांतर परावर्तित होती है। दर्पणों के बीच कोण का मान होगा :

Options :

1. 45°
2. 60°
3. 75°
4. 90°

Question Number : 23 Question Type : MCQ Option Shuffling : Yes Display Question Number : Yes Single Line Question Option : No Option Orientation : Vertical

Correct Marks : 4 Wrong Marks : 1

બે સમતલ અરિસાઓ એક બીજાથી એવી રીતે ઢળતાં રાખવામાં આવ્યા છે કે જેથી પ્રથમ અરિસા (M_1) પર આપાત થતુ પ્રકાશનું કિરણ કે જે બીજા અરિસા (M_2) ને સમાંતર છે અને અંતે બીજા અરિસા (M_2) થી પરાવર્તિત થાય છે કે જે પ્રથમ અરિસા (M_1) ને સમાંતર છે. આ બે અરિસા વચ્ચેનો ખુણો થશે :

Options :

1. 45°
2. 60°
3. 75°
4. 90°

Question Number : 24 Question Type : MCQ Option Shuffling : Yes Display Question Number : Yes Single Line Question Option : No Option Orientation : Vertical

Correct Marks : 4 Wrong Marks : 1

In a Young's double slit experiment, the slits are placed 0.320 mm apart. Light of wavelength $\lambda = 500$ nm is incident on the slits. The total number of bright fringes that are observed in the angular range $-30^\circ \leq \theta \leq 30^\circ$ is :

Options :

1. 320
2. 321
3. 640
4. 641

Question Number : 24 Question Type : MCQ Option Shuffling : Yes Display Question Number : Yes Single Line Question Option : No Option Orientation : Vertical

Correct Marks : 4 Wrong Marks : 1

यंग के एक द्विझिरी उपकरण में झिरियों के बीच दूरी 0.320 mm है। तरंगदैर्घ्य $\lambda = 500$ nm का प्रकाश झिरियों पर पड़ता है। कोणीय परास $-30^\circ \leq \theta \leq 30^\circ$ में दिखने वाली दीप्त फ्रिंजों की संख्या होगी :

Options :

1. 320
2. 321
3. 640
4. 641

Question Number : 24 Question Type : MCQ Option Shuffling : Yes Display Question Number : Yes Single Line Question Option : No Option Orientation : Vertical

Correct Marks : 4 Wrong Marks : 1

यंगना वे स्लिटना प्रयोगमां स्लिटने अेक बीजथी 0.320 mm दूर राभवामां आवे छे. आ स्लिट्स पर $\lambda = 500$ nm नी तरंगलंबाइनो प्रकाश आपात थाय छे. $-30^\circ \leq \theta \leq 30^\circ$ नी कोणीय अवधीमां जेवा भणती प्रकाशित शलाकाओनी कुल संख्या लशे :

Options :

1. 320
2. 321
3. 640
4. 641

Question Number : 25 Question Type : MCQ Option Shuffling : Yes Display Question Number : Yes Single Line Question Option : No Option Orientation : Vertical

Correct Marks : 4 Wrong Marks : 1

The magnetic field associated with a light wave is given, at the origin, by

$$B = B_0 [\sin(3.14 \times 10^7)ct + \sin(6.28 \times 10^7)ct].$$

If this light falls on a silver plate having a work function of 4.7 eV, what will be the maximum kinetic energy of the photo electrons ?

$$(c = 3 \times 10^8 \text{ ms}^{-1}, h = 6.6 \times 10^{-34} \text{ J-s})$$

Options :

1. 7.72 eV
2. 8.52 eV
3. 12.5 eV
4. 6.82 eV

Question Number : 25 Question Type : MCQ Option Shuffling : Yes Display Question Number : Yes Single Line Question Option : No Option Orientation : Vertical

Correct Marks : 4 Wrong Marks : 1

मूलबिंदु पर एक प्रकाशीय तरंग के संगत चुम्बकीय क्षेत्र निम्न है :

$$B = B_0 [\sin(3.14 \times 10^7)ct + \sin(6.28 \times 10^7)ct].$$

यदि यह प्रकाश एक चाँदी की प्लेट, जिसका कार्य फलन 4.7 eV है, पर पड़ता है तो इससे उत्सर्जित फोटोइलेक्ट्रॉनों की अधिकतम गतिज ऊर्जा क्या होगी ?

$$(दिया है : c = 3 \times 10^8 \text{ ms}^{-1}, h = 6.6 \times 10^{-34} \text{ J-s})$$

Options :

1. 7.72 eV

2. 8.52 eV
3. 12.5 eV
4. 6.82 eV

Question Number : 25 Question Type : MCQ Option Shuffling : Yes Display Question Number : Yes Single Line Question Option : No Option Orientation : Vertical

Correct Marks : 4 Wrong Marks : 1

ઉગમબિંદુ એ પ્રકાશ તરંગને સંલગ્ન ચુંબકીય ક્ષેત્રને

$$B = B_0 [\sin(3.14 \times 10^7)ct + \sin(6.28 \times 10^7)ct]$$

પડે આપવામાં આવે છે. જો આ પ્રકાશ કોઈ એક ચાંદીની તકિત કે જેનું કાર્ય વિદ્યેય 4.7 eV હોય તેની પર પડે તો ફોટોઇલેક્ટ્રોનની મહત્તમ ગતિ ઊર્જા કેટલી હશે?

($c = 3 \times 10^8 \text{ ms}^{-1}$, $h = 6.6 \times 10^{-34} \text{ J-s}$ લો.)

Options :

1. 7.72 eV
2. 8.52 eV
3. 12.5 eV
4. 6.82 eV

Question Number : 26 Question Type : MCQ Option Shuffling : Yes Display Question Number : Yes Single Line Question Option : No Option Orientation : Vertical

Correct Marks : 4 Wrong Marks : 1

At a given instant, say $t = 0$, two radioactive substances A and B have equal activities.

The ratio $\frac{R_B}{R_A}$ of their activities after

time t itself decays with time t as e^{-3t} .

If the half-life of A is $\ln 2$, the half-life of B is :

Options :

1. $\frac{\ln 2}{4}$
2. $\frac{\ln 2}{2}$
3. $2\ln 2$

4. $4\ln 2$

Question Number : 26 Question Type : MCQ Option Shuffling : Yes Display Question Number : Yes Single Line Question Option : No Option Orientation : Vertical

Correct Marks : 4 Wrong Marks : 1

दिये गये एक क्षण, $t=0$ पर दो रेडियोधर्मी पदार्थों, A तथा B, की सक्रियता बराबर है। समय t के पश्चात,

इनकी सक्रियता का अनुपात $\frac{R_B}{R_A}$ समय t के साथ

e^{-3t} के अनुसार घटता है। यदि A की अर्धआयु $\ln 2$ है, तो B की अर्धआयु होगी :

Options :

1. $\frac{\ln 2}{4}$

2. $\frac{\ln 2}{2}$

3. $2\ln 2$

4. $4\ln 2$

Question Number : 26 Question Type : MCQ Option Shuffling : Yes Display Question Number : Yes Single Line Question Option : No Option Orientation : Vertical

Correct Marks : 4 Wrong Marks : 1

આપેલ ક્ષણે, $t=0$, બે રેડિયોએક્ટિવ દ્રવ્યો A અને B ની એક્ટિવિટી સમાન છે. t સમય બાદ તેમની

એક્ટિવિટીઓનો ગુણોત્તર $\frac{R_B}{R_A}$ સમય t સાથે e^{-3t}

વડે ક્ષય પામે છે. જો A નો અર્ધઆયુષ્યકાળ $\ln 2$ છે, તો B નો અર્ધઆયુષ્યકાળ હશે :

Options :

1. $\frac{\ln 2}{4}$

2. $\frac{\ln 2}{2}$

3. $2\ln 2$

4. $4\ln 2$

Question Number : 27 Question Type : MCQ Option Shuffling : Yes Display Question Number : Yes Single Line Question Option : No Option Orientation : Vertical

Correct Marks : 4 Wrong Marks : 1

Ge and Si diodes start conducting at 0.3 V and 0.7 V respectively. In the following figure if Ge diode connection are reversed, the value of V_o changes by : (assume that the Ge diode has large breakdown voltage)

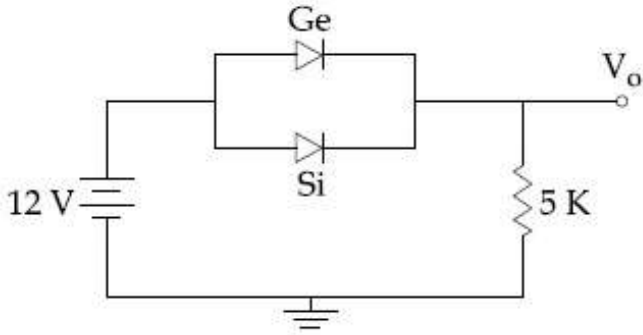

Options :

1. 0.4 V
2. 0.2 V
3. 0.6 V
4. 0.8 V

Question Number : 27 Question Type : MCQ Option Shuffling : Yes Display Question Number : Yes Single Line Question Option : No Option Orientation : Vertical

Correct Marks : 4 Wrong Marks : 1

Ge तथा Si के डायोड, क्रमशः 0.3 V तथा 0.7 V पर सुचालक हो जाते हैं। दिय गये चित्र में यदि Ge डायोड के सिरों को पलट दिया जाये तो विभव V_o में परिवर्तन का मान होगा : (मान लें कि Ge डायोड की भंजन वोल्टता अत्यधिक है।)

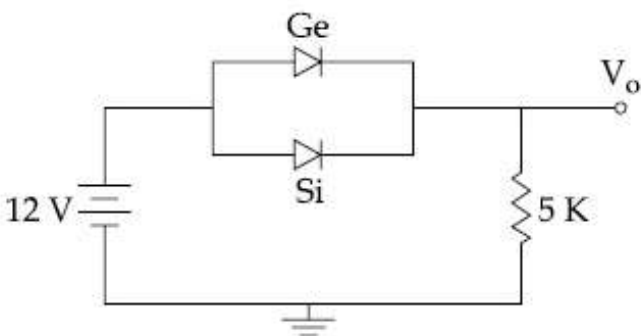

Options :

1. 0.4 V

2. 0.2 V
3. 0.6 V
4. 0.8 V

Question Number : 27 Question Type : MCQ Option Shuffling : Yes Display Question Number : Yes Single Line Question Option : No Option Orientation : Vertical

Correct Marks : 4 Wrong Marks : 1

Ge અને Si ડાયોડ ક્રમશઃ 0.3 V અને 0.7 V પર વહન ચાલુ કરે છે. નીચેના પરિપથમાં જો Ge ડાયોડનું જોડાણ ઉલ્ટાવવામાં આવે તો V_o નું મૂલ્ય _____ જેટલું બદલાશે. (ધારો કે Ge ડાયોડ નો બ્રેકડાઉન વોલ્ટેજ મોટો છે.)

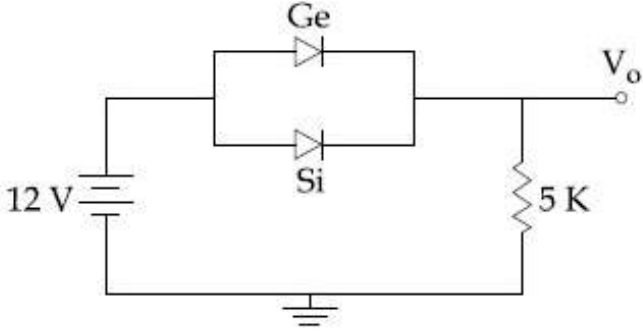

Options :

1. 0.4 V
2. 0.2 V
3. 0.6 V
4. 0.8 V

Question Number : 28 Question Type : MCQ Option Shuffling : Yes Display Question Number : Yes Single Line Question Option : No Option Orientation : Vertical

Correct Marks : 4 Wrong Marks : 1

In a communication system operating at wavelength 800 nm, only one percent of source frequency is available as signal bandwidth. The number of channels accommodated for transmitting TV signals of band width 6 MHz are (Take velocity of light $c = 3 \times 10^8 \text{ m/s}$, $h = 6.6 \times 10^{-34} \text{ J-s}$)

Options :

1. 6.25×10^5

2. 3.86×10^6

3. 4.87×10^5

4. 3.75×10^6

Question Number : 28 Question Type : MCQ Option Shuffling : Yes Display Question Number : Yes Single Line Question Option : No Option Orientation : Vertical

Correct Marks : 4 Wrong Marks : 1

800 nm तरंगदैर्घ्य पर कार्य करते हुए एक संचार व्यवस्था में सिग्नल की कुल स्रोत आवृत्ति का मात्र एक प्रतिशत बैंड चौड़ाई के लिए उपयोग कर सकते हैं। 6 MHz बैंड चौड़ाई के TV सिग्नलों वाले कितने चैनलों को इससे संचारित किया जा सकता है?

(दिया है : $c = 3 \times 10^8 \text{m/s}$, $h = 6.6 \times 10^{-34} \text{J-s}$)

Options :

1. 6.25×10^5

2. 3.86×10^6

3. 4.87×10^5

4. 3.75×10^6

Question Number : 28 Question Type : MCQ Option Shuffling : Yes Display Question Number : Yes Single Line Question Option : No Option Orientation : Vertical

Correct Marks : 4 Wrong Marks : 1

800 nm तरंगलंबाई पर कार्यरत एक संचारव्यवस्था में कुल आवृत्ति का सिग्नल बैंडविड्थ का मात्र एक प्रतिशत बैंड चौड़ाई के लिए उपयोग कर सकते हैं। 6 MHz बैंड चौड़ाई के TV सिग्नलों वाले कितने चैनलों को इससे संचारित किया जा सकता है?

(प्रकाश की वेग $c = 3 \times 10^8 \text{m/s}$, $h = 6.6 \times 10^{-34} \text{J-s}$ लें)

Options :

1. 6.25×10^5

2. 3.86×10^6

3. 4.87×10^5

4. 3.75×10^6

Question Number : 29 Question Type : MCQ Option Shuffling : Yes Display Question Number : Yes Single Line Question Option : No Option Orientation : Vertical

Correct Marks : 4 Wrong Marks : 1

एक कार्बन प्रतिरोध का कलर कोड निम्न है। इसके प्रतिरोध का मान होगा :

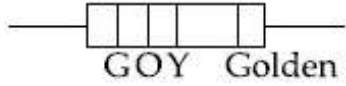

Options :

1. $6.4 \text{ M}\Omega \pm 5\%$
2. $530 \text{ k}\Omega \pm 5\%$
3. $64 \text{ k}\Omega \pm 10\%$
4. $5.3 \text{ M}\Omega \pm 5\%$

Question Number : 29 Question Type : MCQ Option Shuffling : Yes Display Question Number : Yes Single Line Question Option : No Option Orientation : Vertical

Correct Marks : 4 Wrong Marks : 1

એક કાર્બન અવરોધ નિમ્ન વર્ણ સકેતો ધરાવે છે. આ અવરોધનું મૂલ્ય શું છે?



Options :

1. $6.4 \text{ M}\Omega \pm 5\%$
2. $530 \text{ k}\Omega \pm 5\%$
3. $64 \text{ k}\Omega \pm 10\%$
4. $5.3 \text{ M}\Omega \pm 5\%$

Question Number : 29 Question Type : MCQ Option Shuffling : Yes Display Question Number : Yes Single Line Question Option : No Option Orientation : Vertical

Correct Marks : 4 Wrong Marks : 1

A carbon resistance has a following colour code. What is the value of the resistance ?

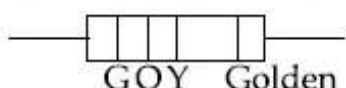

Options :

1. $6.4 \text{ M}\Omega \pm 5\%$
2. $530 \text{ k}\Omega \pm 5\%$
3. $64 \text{ k}\Omega \pm 10\%$
4. $5.3 \text{ M}\Omega \pm 5\%$

Question Number : 30 Question Type : MCQ Option Shuffling : Yes Display Question Number : Yes Single Line Question Option : No Option Orientation : Vertical

Correct Marks : 4 Wrong Marks : 1

The pitch and the number of divisions, on the circular scale, for a given screw gauge are 0.5 mm and 100 respectively. When the screw gauge is fully tightened without any object, the zero of its circular scale lies 3 divisions below the mean line.

The readings of the main scale and the circular scale, for a thin sheet, are 5.5 mm and 48 respectively, the thickness of this sheet is :

Options :

1. 5.725 mm
2. 5.755 mm
3. 5.950 mm
4. 5.740 mm

Question Number : 30 Question Type : MCQ Option Shuffling : Yes Display Question Number : Yes Single Line Question Option : No Option Orientation : Vertical

Correct Marks : 4 Wrong Marks : 1

एक पेचमापी की पिच तथा वृत्तीय पैमाने पर भागों की संख्या, क्रमशः 0.5 mm तथा 100 हैं। जब पेचमापी को बिना किसी वस्तु के पूरी तरह कस दिया जाता है, तो इसके वृत्तीय पैमाने का शून्य मध्य रेखा से तीन भाग नीचे आता है।

एक पतली चदर की मोटाई के लिए इस पेचमापी के मुख्य पैमाने तथा वृत्तीय पैमाने का पाठ्यांक, क्रमशः 5.5 mm तथा 48 हैं। तो चदर की मोटाई होगी :

Options :

1. 5.725 mm
2. 5.755 mm
3. 5.950 mm
4. 5.740 mm

Question Number : 30 Question Type : MCQ Option Shuffling : Yes Display Question Number : Yes Single Line Question Option : No Option Orientation : Vertical

Correct Marks : 4 Wrong Marks : 1

આપેલ એક સ્ક્રૂગેજમાં વર્તુળાકાર સ્કેલ પર પિચ અને કાપાઓની સંખ્યા અનુક્રમે 0.5 mm અને 100 છે. જ્યારે આ સ્ક્રૂગેજ પૂર્ણતઃ કોઈપણ પદાર્થ વગર બંધ છે, ત્યારે વર્તુળાકાર માપપટ્ટી નું શૂન્ય સરેરાસ રેખાની 3 કાપા નીચે છે. એક પાતળી તકિતમાટે મુખ્ય માપપટ્ટી અને વર્તુળાકાર માપપટ્ટીના વાંચનો અનુક્રમે 5.5 mm અને 48 છે. આ તકિતની જાડાઈ હશે :

Options :

1. 5.725 mm
2. 5.755 mm
3. 5.950 mm
4. 5.740 mm

Section Id :	Chemistry
Section Number :	416529119
Section type :	2
Mandatory or Optional:	Online
Number of Questions:	Mandatory
Number of Questions to be attempted:	30
Section Marks:	30
Display Number Panel:	120
Group All Questions:	Yes
	No

Sub-Section Number:	1
Sub-Section Id:	416529128
Question Shuffling Allowed :	Yes

Question Number : 31 Question Type : MCQ Option Shuffling : Yes Display Question Number : Yes Single Line Question Option : No Option Orientation : Vertical

Correct Marks : 4 Wrong Marks : 1

The major product of the following reaction is :

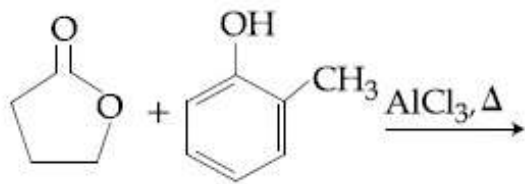

Options :

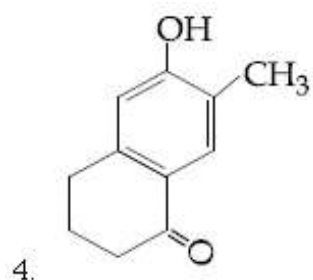
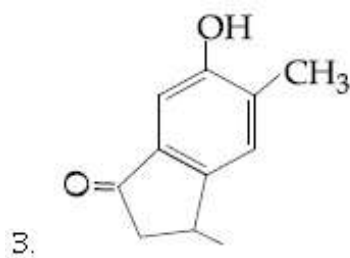
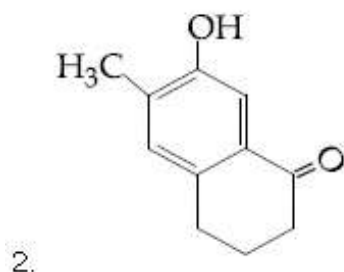
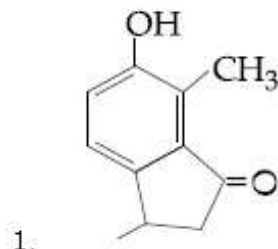

Question Number : 31 Question Type : MCQ Option Shuffling : Yes Display Question Number : Yes Single Line Question Option : No Option Orientation : Vertical

Correct Marks : 4 Wrong Marks : 1

निम्नलिखित अभिक्रिया का मुख्य उत्पाद है :

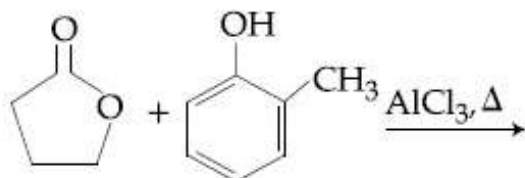

Options :

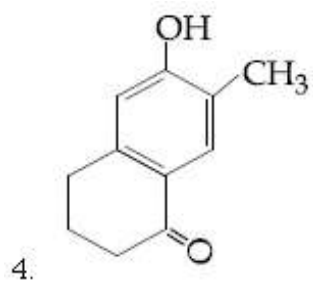
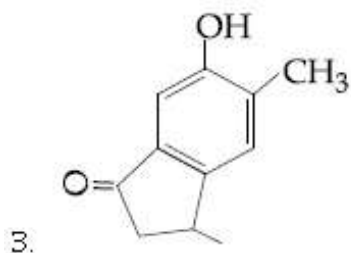
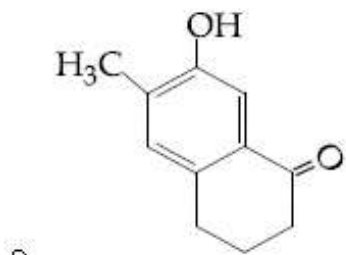
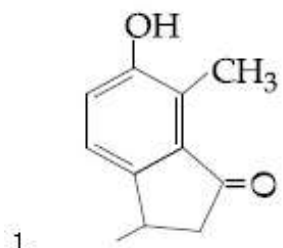

Question Number : 31 Question Type : MCQ Option Shuffling : Yes Display Question Number : Yes Single Line Question Option : No Option Orientation : Vertical Correct Marks : 4 Wrong Marks : 1

આપેલી પ્રક્રિયાની મુખ્ય નીપજ શોધો ?

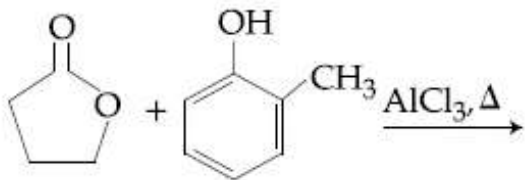

Options :

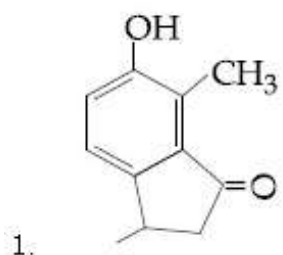

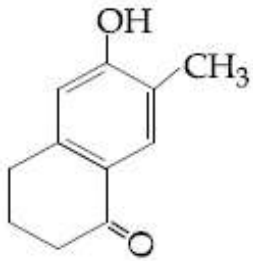
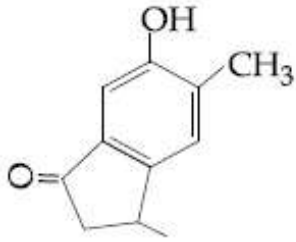
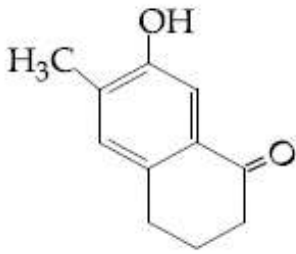

Question Number : 32 Question Type : MCQ Option Shuffling : Yes Display Question Number : Yes Single Line Question Option : No Option Orientation : Vertical

Correct Marks : 4 Wrong Marks : 1

निम्न में से कौन सा यौगिक ऐरोमैटिक नहीं है ?

Options :

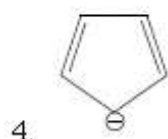
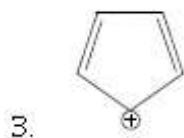
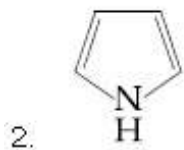
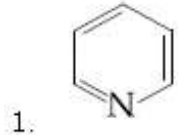

Question Number : 32 Question Type : MCQ Option Shuffling : Yes Display Question Number : Yes Single Line Question Option : No Option Orientation : Vertical

Correct Marks : 4 Wrong Marks : 1

नीचे आपेला पैकी क्यो संयोजन अरोमेटिक नथी?

Options :

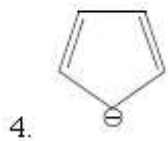
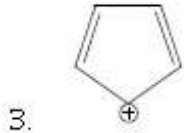
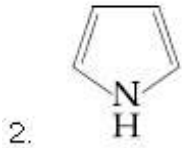
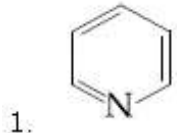

Question Number : 32 Question Type : MCQ Option Shuffling : Yes Display Question Number : Yes Single Line Question Option : No Option Orientation : Vertical

Correct Marks : 4 Wrong Marks : 1

Which of the following compounds is not aromatic ?

Options :

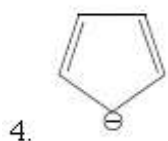
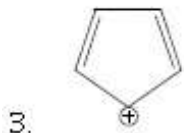
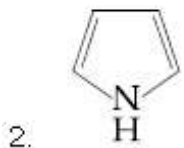
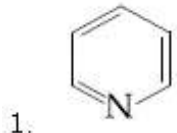

Question Number : 33 Question Type : MCQ Option Shuffling : Yes Display Question Number : Yes Single Line Question Option : No Option Orientation : Vertical

Correct Marks : 4 Wrong Marks : 1

The major product of the following reaction is :

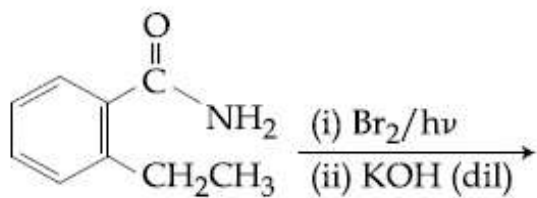

Options :

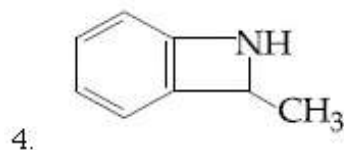
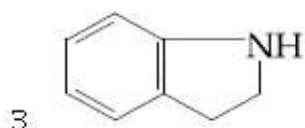
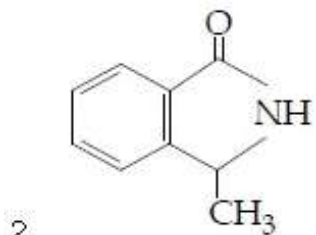
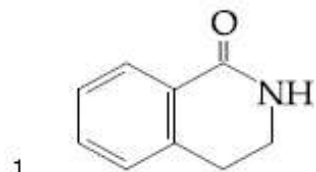

Question Number : 33 Question Type : MCQ Option Shuffling : Yes Display Question Number : Yes Single Line Question Option : No Option Orientation : Vertical

Correct Marks : 4 Wrong Marks : 1

निम्नलिखित अभिक्रिया का मुख्य उत्पाद है :

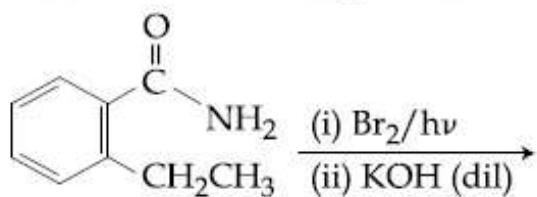

Options :

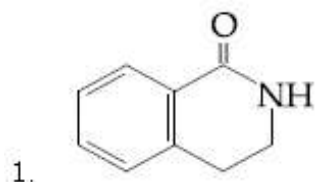

2.

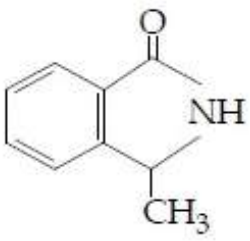

3.

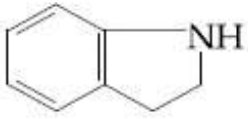

4.

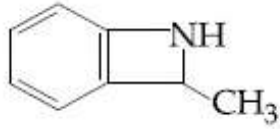

Question Number : 33 Question Type : MCQ Option Shuffling : Yes Display Question Number : Yes Single Line Question Option : No Option Orientation : Vertical

Correct Marks : 4 Wrong Marks : 1

નીચેની પ્રક્રિયાની મુખ્ય નીપજ શોધો ?

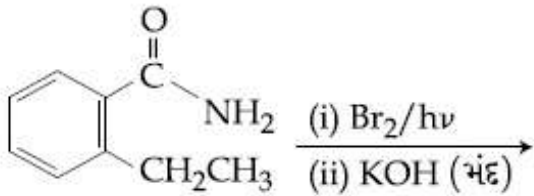

Options :

1.

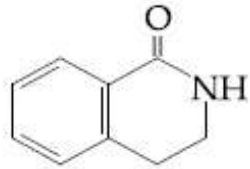

2.

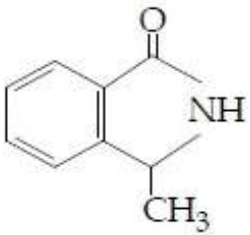

3.

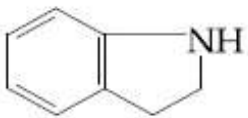

4.

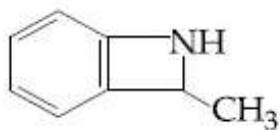

Question Number : 34 Question Type : MCQ Option Shuffling : Yes Display Question Number : Yes Single Line Question Option : No Option Orientation : Vertical

Correct Marks : 4 Wrong Marks : 1

The products formed in the reaction of cumene with O_2 followed by treatment with dil. HCl are :

Options :

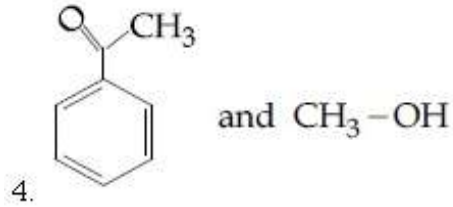
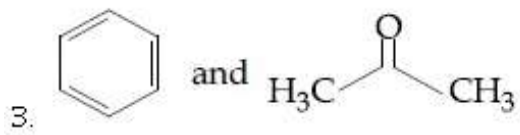
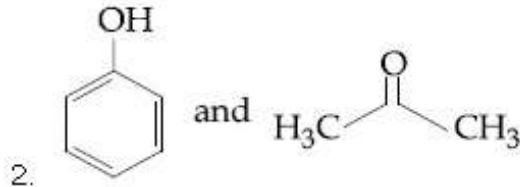
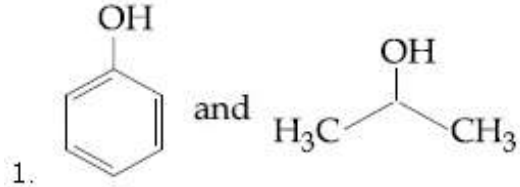

Question Number : 34 Question Type : MCQ Option Shuffling : Yes Display Question Number : Yes Single Line Question Option : No Option Orientation : Vertical

Correct Marks : 4 Wrong Marks : 1

क्यूमीन की O_2 के साथ अभिक्रिया करने के तत्पश्चात् तनु HCl के साथ विवेचन करने पर बनने वाले उत्पाद हैं :

Options :

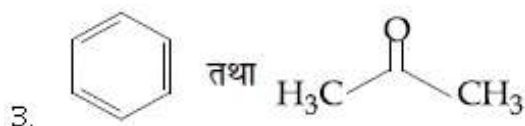
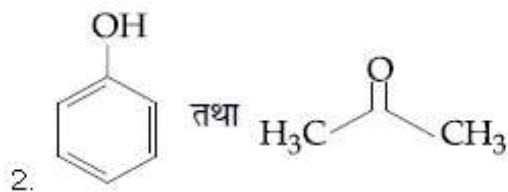
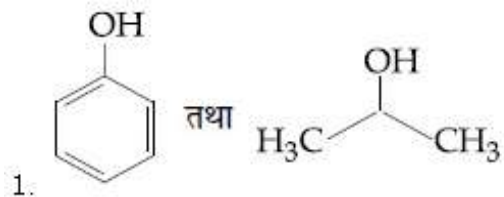

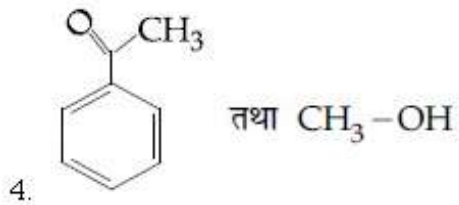

Question Number : 34 Question Type : MCQ Option Shuffling : Yes Display Question Number : Yes Single Line Question Option : No Option Orientation : Vertical

Correct Marks : 4 Wrong Marks : 1

ક્યુમિન ની O_2 સાથે પ્રક્રિયા કર્યા બાદ તેની મંદ HCl સાથે પ્રક્રિયા કરતા મળતી નીપજે શોધો?

Options :

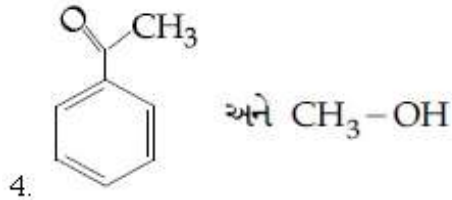
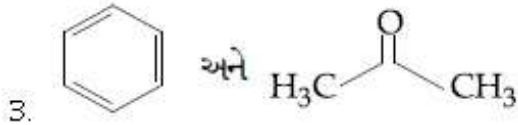
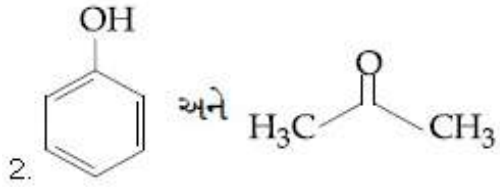
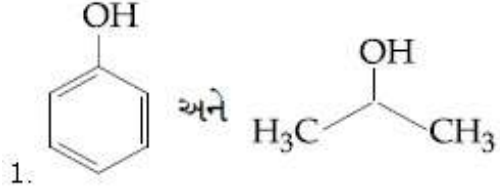

Question Number : 35 Question Type : MCQ Option Shuffling : Yes Display Question Number : Yes Single Line Question Option : No Option Orientation : Vertical

Correct Marks : 4 Wrong Marks : 1

The major product formed in the following reaction is :

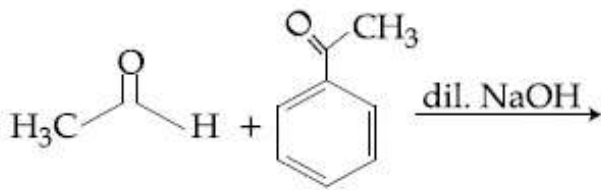

Options :

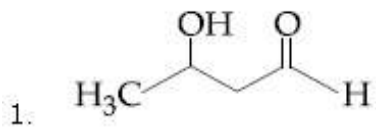

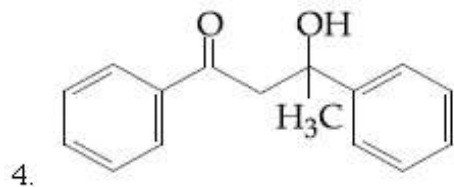
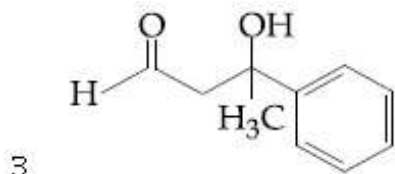
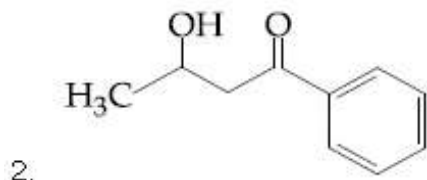

Question Number : 35 Question Type : MCQ Option Shuffling : Yes Display Question Number : Yes Single Line Question Option : No Option Orientation : Vertical

Correct Marks : 4 Wrong Marks : 1

निम्नलिखित अभिक्रिया का मुख्य उत्पाद है :

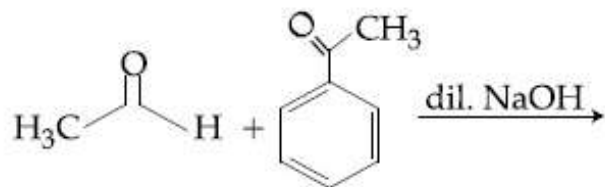

Options :

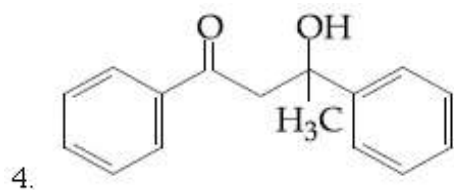
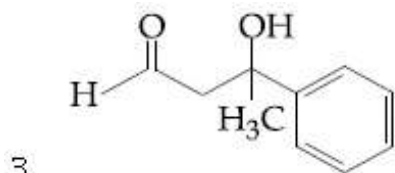
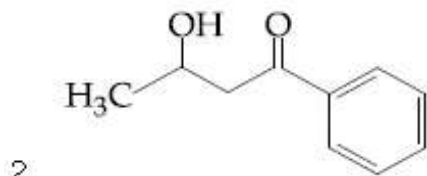
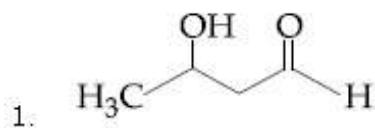

Question Number : 35 Question Type : MCQ Option Shuffling : Yes Display Question Number : Yes Single Line Question Option : No Option Orientation : Vertical

Correct Marks : 4 Wrong Marks : 1

नीचे आपेती प्रक्रियानी मुख्य नीपण शोधो?

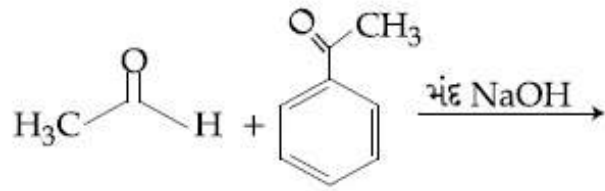

Options :

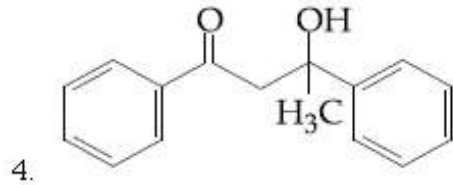
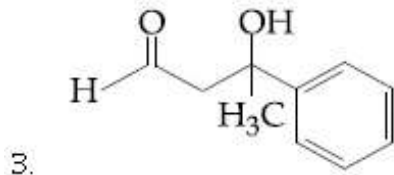
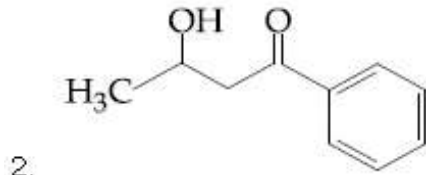
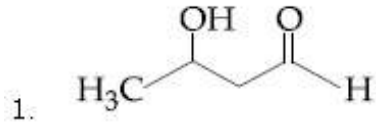

Question Number : 36 Question Type : MCQ Option Shuffling : Yes Display Question Number : Yes Single Line Question Option : No Option Orientation : Vertical

Correct Marks : 4 Wrong Marks : 1

The increasing basicity order of the following compounds is :

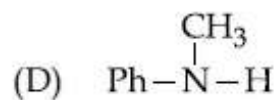
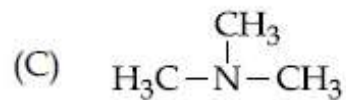
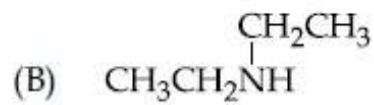
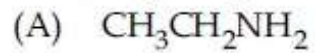

Options :

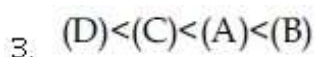
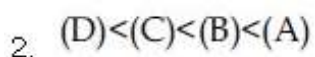
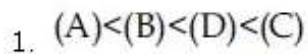

4. (A)<(B)<(C)<(D)

Question Number : 36 Question Type : MCQ Option Shuffling : Yes Display Question Number : Yes Single Line Question Option : No Option Orientation : Vertical

Correct Marks : 4 Wrong Marks : 1

निम्नलिखित यौगिकों में क्षारकता का बढ़ता क्रम है :

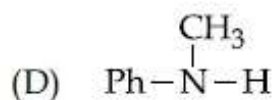
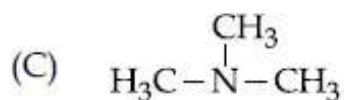
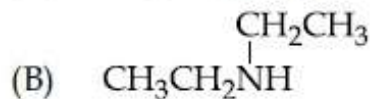
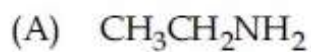

Options :

1. (A)<(B)<(D)<(C)

2. (D)<(C)<(B)<(A)

3. (D)<(C)<(A)<(B)

4. (A)<(B)<(C)<(D)

Question Number : 36 Question Type : MCQ Option Shuffling : Yes Display Question Number : Yes Single Line Question Option : No Option Orientation : Vertical

Correct Marks : 4 Wrong Marks : 1

नीचे आपले संयोजनों की बेजिकता को बढ़ते क्रम शोधो ?

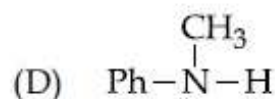
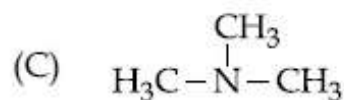
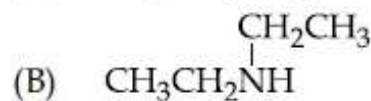

Options :

1. (A)<(B)<(D)<(C)

2. (D)<(C)<(B)<(A)

3. (D)<(C)<(A)<(B)

4. (A)<(B)<(C)<(D)

Question Number : 37 Question Type : MCQ Option Shuffling : Yes Display Question Number : Yes Single Line Question Option : No Option Orientation : Vertical

Correct Marks : 4 Wrong Marks : 1

The correct sequence of amino acids present in the tripeptide given below is :

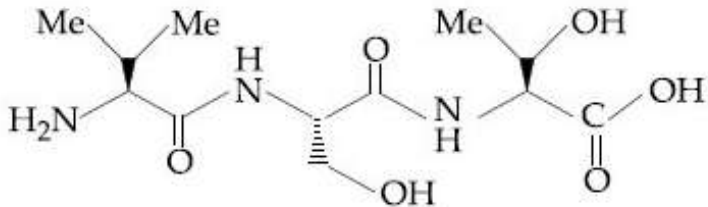

Options :

1. Leu - Ser - Thr

2. Thr - Ser - Leu

3. Val - Ser - Thr

4. Thr - Ser - Val

Question Number : 37 Question Type : MCQ Option Shuffling : Yes Display Question Number : Yes Single Line Question Option : No Option Orientation : Vertical

Correct Marks : 4 Wrong Marks : 1

नीचे दिये ट्राइपेप्टाइड में ऐमीनो अम्लों का सही क्रम है :

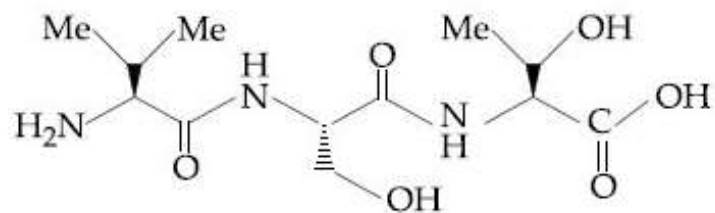

Options :

1. Leu - Ser - Thr

2. Thr - Ser - Leu

3. Val - Ser - Thr

4. Thr - Ser - Val

Question Number : 37 Question Type : MCQ Option Shuffling : Yes Display Question Number : Yes Single Line Question Option : No Option Orientation : Vertical

Correct Marks : 4 Wrong Marks : 1

નીચે આપેલા ટ્રાઇપેપ્ટાઇડ માં રહેલા એમિનો એસિડ નો સાચો ક્રમ શોધો ?

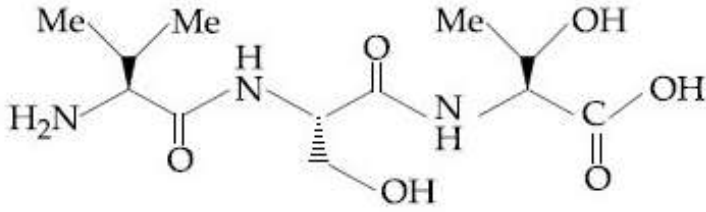

Options :

1. Leu - Ser - Thr
2. Thr - Ser - Leu
3. Val - Ser - Thr
4. Thr - Ser - Val

Question Number : 38 Question Type : MCQ Option Shuffling : Yes Display Question Number : Yes Single Line Question Option : No Option Orientation : Vertical

Correct Marks : 4 Wrong Marks : 1

The tests performed on compound X and their inferences are :

Test	Inference
(a) 2, 4 - DNP test	Coloured precipitate
(b) Iodoform test	Yellow precipitate
(c) Azo-dye test	No dye formation

Compound 'X' is :

Options :

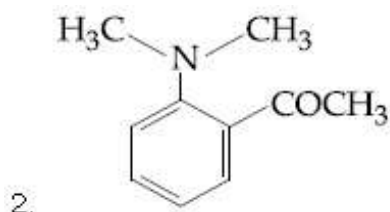
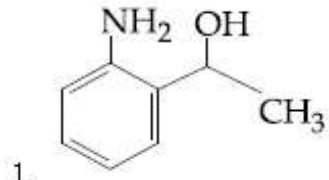

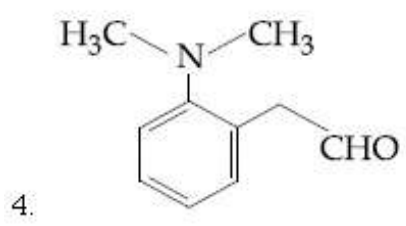
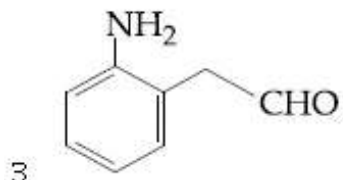

Question Number : 38 Question Type : MCQ Option Shuffling : Yes Display Question Number : Yes Single Line Question Option : No Option Orientation : Vertical
 Correct Marks : 4 Wrong Marks : 1

यौगिक X पर किये गये परीक्षण निम्न निष्कर्ष देते हैं :

परीक्षण	निष्कर्ष
(a) 2, 4 - DNP परीक्षण	रंगीन अवक्षेप
(b) आयडोफार्म परीक्षण	पीला अवक्षेप बनना
(c) ऐजो-डाई परीक्षण	डाई नहीं बनना

यौगिक 'X' है :

Options :

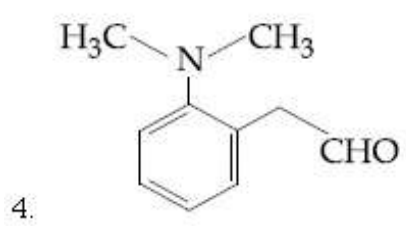
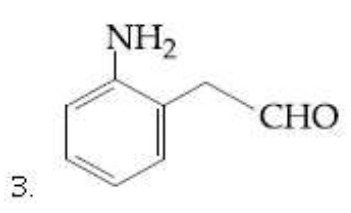
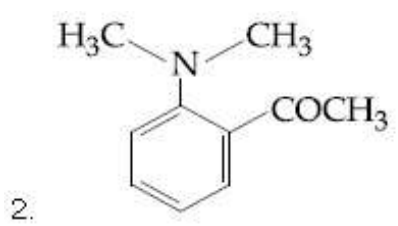
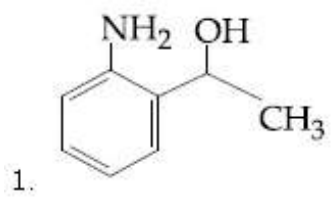

Question Number : 38 Question Type : MCQ Option Shuffling : Yes Display Question Number : Yes Single Line Question Option : No Option Orientation : Vertical

Correct Marks : 4 Wrong Marks : 1

સંયોજન X સાથે કરેલી કસોટી અને તેના અનુમાનો

કસોટી	અનુમાન
(a) 2,4 - DNP કસોટી	રંગીન અવક્ષેપ
(b) આયોડોફોર્મ કસોટી	પીળા અવક્ષેપ
(c) એઝો રંગક કસોટી	કોઈ રંગક (dye) બનશે નહીં

તો સંયોજન X નું બધારકા નીચેનામાંથી શોધો ?

Options :

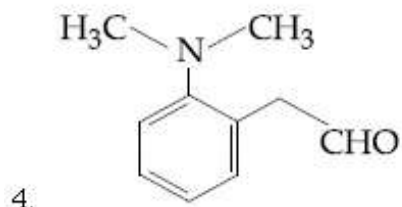
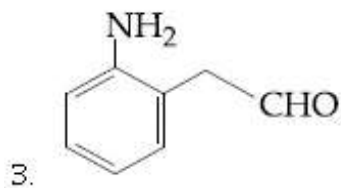
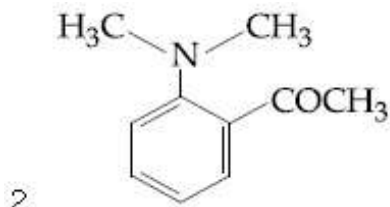
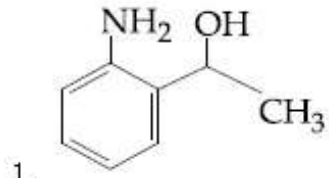

Question Number : 39 Question Type : MCQ Option Shuffling : Yes Display Question Number : Yes Single Line Question Option : No Option Orientation : Vertical

Correct Marks : 4 Wrong Marks : 1

The major product obtained in the following reaction is :

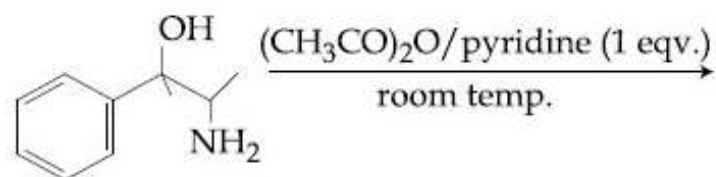

Options :

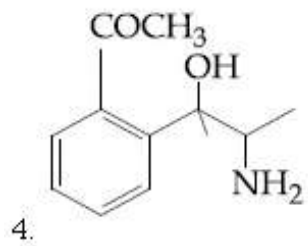
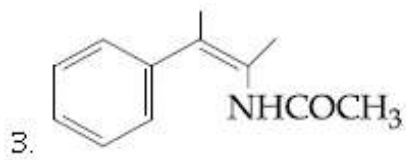
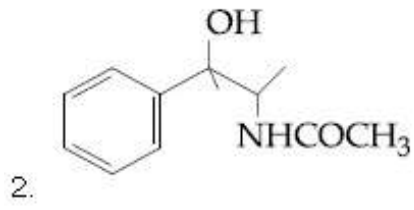
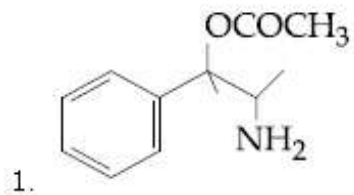

Question Number : 39 Question Type : MCQ Option Shuffling : Yes Display Question Number : Yes Single Line Question Option : No Option Orientation : Vertical

Correct Marks : 4 Wrong Marks : 1

निम्न अभिक्रिया में प्राप्त होने वाला मुख्य उत्पाद है :

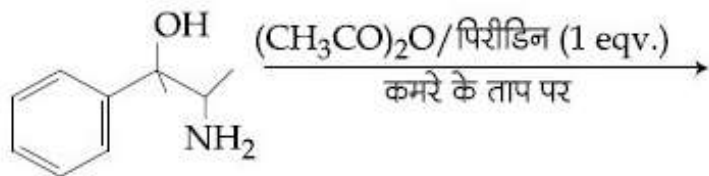

Options :

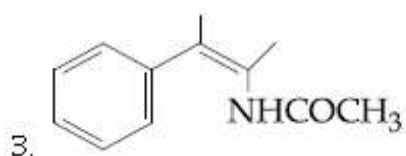
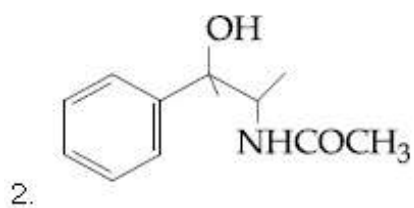
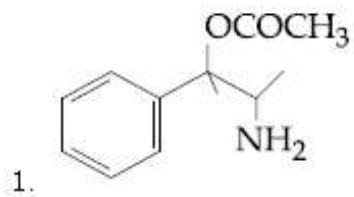

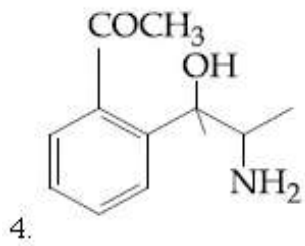

Question Number : 39 Question Type : MCQ Option Shuffling : Yes Display Question Number : Yes Single Line Question Option : No Option Orientation : Vertical

Correct Marks : 4 Wrong Marks : 1

नीचे आपेसी प्रक्रिया भणती मुख्य नीपण शोधो?

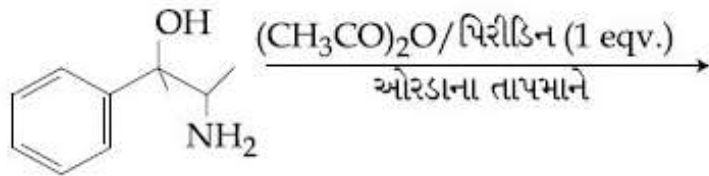

Options :

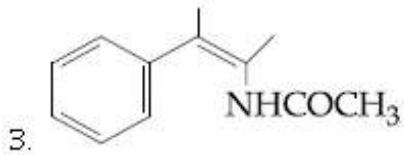
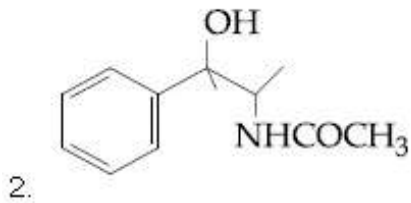
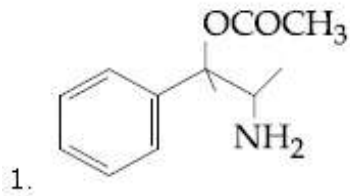

Question Number : 40 Question Type : MCQ Option Shuffling : Yes Display Question Number : Yes Single Line Question Option : No Option Orientation : Vertical

Correct Marks : 4 Wrong Marks : 1

The correct match between Item I and Item II is :

Item I	Item II
(A) Benzaldehyde	(P) Mobile phase
(B) Alumina	(Q) Adsorbent
(C) Acetonitrile	(R) Adsorbate

Options :

1. (A) \rightarrow (P) ; (B) \rightarrow (R) ; (C) \rightarrow (Q)
2. (A) \rightarrow (Q) ; (B) \rightarrow (P) ; (C) \rightarrow (R)
3. (A) \rightarrow (Q) ; (B) \rightarrow (R) ; (C) \rightarrow (P)
4. (A) \rightarrow (R) ; (B) \rightarrow (Q) ; (C) \rightarrow (P)

Question Number : 40 Question Type : MCQ Option Shuffling : Yes Display Question Number : Yes Single Line Question Option : No Option Orientation : Vertical

Correct Marks : 4 Wrong Marks : 1

मद I तथा मद II के बीच सही सुमेल है :

मद I	मद II
(A) बेंजाल्डिहाइड	(P) गतिशील प्रावस्था
(B) एल्यूमिना	(Q) अधिशोषक
(C) ऐसिटोनाइट्राइल	(R) अधिशोष्य

Options :

1. (A) \rightarrow (P) ; (B) \rightarrow (R) ; (C) \rightarrow (Q)
2. (A) \rightarrow (Q) ; (B) \rightarrow (P) ; (C) \rightarrow (R)
3. (A) \rightarrow (Q) ; (B) \rightarrow (R) ; (C) \rightarrow (P)
4. (A) \rightarrow (R) ; (B) \rightarrow (Q) ; (C) \rightarrow (P)

Question Number : 40 Question Type : MCQ Option Shuffling : Yes Display Question Number : Yes Single Line Question Option : No Option Orientation : Vertical

Correct Marks : 4 Wrong Marks : 1

सूचि - I અને सूचि - II ने योग्य रीते जोडो :

- | सूचि - I | सूचि - II |
|---------------------|--------------------------------|
| (A) बेन्जालडीहाईड | (P) चलित कला
(Mobile phase) |
| (B) अल्युमिना | (Q) अधिशोषक |
| (C) अेसिटोनाईट्राईल | (R) अधिशोषित |

Options :

1. (A) → (P) ; (B) → (R) ; (C) → (Q)
2. (A) → (Q) ; (B) → (P) ; (C) → (R)
3. (A) → (Q) ; (B) → (R) ; (C) → (P)
4. (A) → (R) ; (B) → (Q) ; (C) → (P)

Question Number : 41 Question Type : MCQ Option Shuffling : Yes Display Question Number : Yes Single Line Question Option : No Option Orientation : Vertical

Correct Marks : 4 Wrong Marks : 1

When the first electron gain enthalpy ($\Delta_{eg}H$) of oxygen is -141 kJ/mol , its second electron gain enthalpy is :

Options :

1. a positive value
2. a more negative value than the first
3. negative, but less negative than the first
4. almost the same as that of the first

Question Number : 41 Question Type : MCQ Option Shuffling : Yes Display Question Number : Yes Single Line Question Option : No Option Orientation : Vertical

Correct Marks : 4 Wrong Marks : 1

यदि आक्सीजन की प्रथम इलेक्ट्रान लब्धि एंथैल्पी ($\Delta_{eg}H$) का मान -141 kJ/mol है, इसके द्वितीय इलेक्ट्रान लब्धि एंथैल्पी का मान है :

Options :

1. धनात्मक
2. पहले से और ऋणात्मक

3. ऋणात्मक लेकिन पहले से कम ऋणात्मक

4. पहले मान के लगभग बराबर

Question Number : 41 Question Type : MCQ Option Shuffling : Yes Display Question Number : Yes Single Line Question Option : No Option Orientation : Vertical

Correct Marks : 4 Wrong Marks : 1

ओक्सीजनની પ્રથમ ઇલેક્ટ્રોન ગ્રાહ્ય (gain) એન્ટાલ્પી ($\Delta_{eg}H$) -141 kJ/mol આપેલ છે. તેની દ્વિતીય ઇલેક્ટ્રોન ગ્રાહ્ય એન્ટાલ્પી માટે શું અપેક્ષા છે?

Options :

1. તે ધન હોય શકે.

2. પ્રથમ કરતા વધુ ઋણ હોઈ શકે.

3. ઋણ, પરંતુ, પહેલા કરતા ઓછી ઋણ હોઈ શકે.

4. લગભગ પહેલા જેટલી જ ઋણ હોઈ શકે.

Question Number : 42 Question Type : MCQ Option Shuffling : Yes Display Question Number : Yes Single Line Question Option : No Option Orientation : Vertical

Correct Marks : 4 Wrong Marks : 1

The correct statement regarding the given Ellingham diagram is :

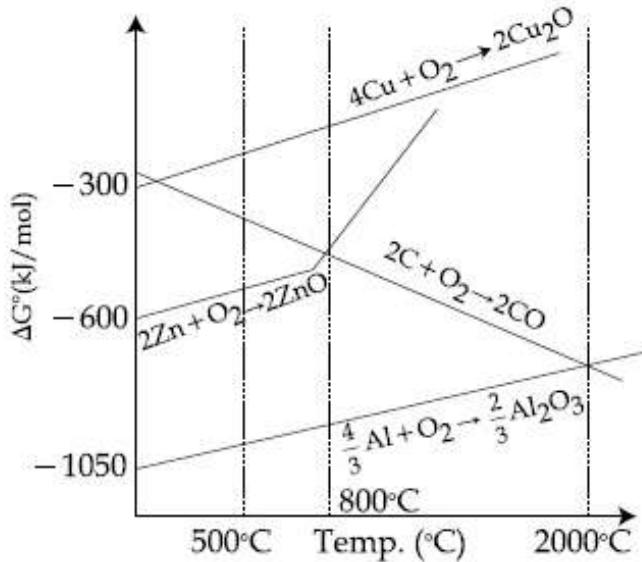

Options :

1. Coke cannot be used for the extraction of Cu from Cu_2O .

2. At 1400°C , Al can be used for the extraction of Zn from ZnO

3. At 500°C, coke can be used for the extraction of Zn from ZnO

4. At 800°C, Cu can be used for the extraction of Zn from ZnO.

Question Number : 42 Question Type : MCQ Option Shuffling : Yes Display Question Number : Yes Single Line Question Option : No Option Orientation : Vertical

Correct Marks : 4 Wrong Marks : 1

दिए गए आरेखीय एलिंघम आलेख के संबंध में सत्य कथन है :

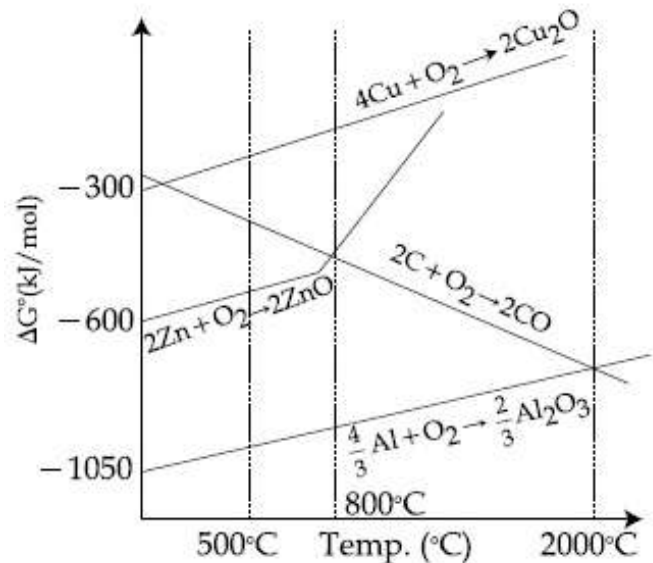

Options :

1. Cu_2O से Cu का निष्कर्षण कोक का प्रयोग करके नहीं किया जा सकता है।

2. ZnO से Zn का निष्कर्षण 1400°C पर Al का प्रयोग करके किया जा सकता है।

3. ZnO से Zn का निष्कर्षण 500°C पर कोक का प्रयोग करके किया जा सकता है।

4. ZnO से Zn का निष्कर्षण 800°C पर Cu का प्रयोग करके किया जा सकता है।

Question Number : 42 Question Type : MCQ Option Shuffling : Yes Display Question Number : Yes Single Line Question Option : No Option Orientation : Vertical

Correct Marks : 4 Wrong Marks : 1

એલિંગહામ (Ellingham) રેખાકૃતિ માટે સાચુ વિધાન શોધો?

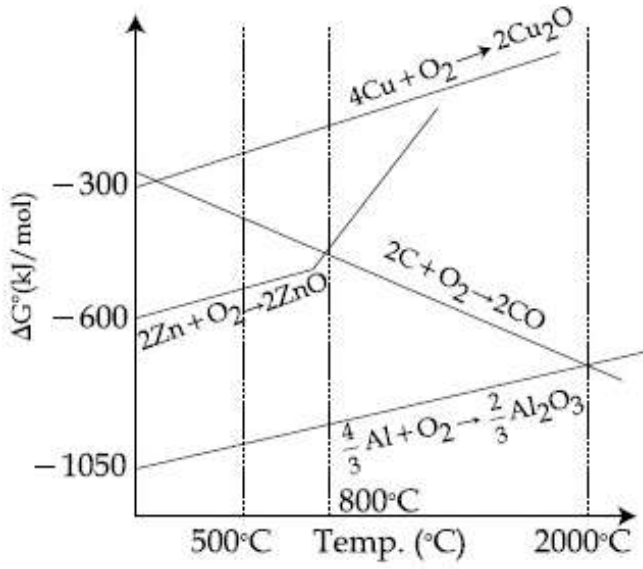

Options :

Cu₂O માંથી Cu ને નિષ્કર્ષિત કરવા માટે કોક

1. (Coke) નો ઉપયોગ કરી શકાય નહીં.

1400°C એ Al નો ઉપયોગ ZnO માંથી Zn

2. નું નિષ્કર્ષણ કરવા માટે કરી શકાય.

500°C એ Coke નો ઉપયોગ ZnO માંથી Zn

3. ના નિષ્કર્ષણ માટે કરી શકાય.

800°C એ Cu નો ઉપયોગ ZnO માંથી Zn ના

4. નિષ્કર્ષણ માટે કરી શકાય.

Question Number : 43 Question Type : MCQ Option Shuffling : Yes Display Question Number : Yes Single Line Question Option : No Option Orientation : Vertical

Correct Marks : 4 Wrong Marks : 1

The temporary hardness of water is due to :

Options :

1. CaCl₂

2. Ca(HCO₃)₂

3. NaCl

4. Na₂SO₄

Question Number : 43 Question Type : MCQ Option Shuffling : Yes Display Question Number : Yes Single Line Question Option : No Option Orientation : Vertical

Correct Marks : 4 Wrong Marks : 1

पानी की अस्थायी कठोरता का कारण है :

Options :

1. CaCl_2
2. $\text{Ca}(\text{HCO}_3)_2$
3. NaCl
4. Na_2SO_4

Question Number : 43 Question Type : MCQ Option Shuffling : Yes Display Question Number : Yes Single Line Question Option : No Option Orientation : Vertical

Correct Marks : 4 Wrong Marks : 1

પાણીની અસ્થાયી કઠોરતા નીચેનામાંથી કયા એકને આભારી છે?

Options :

1. CaCl_2
2. $\text{Ca}(\text{HCO}_3)_2$
3. NaCl
4. Na_2SO_4

Question Number : 44 Question Type : MCQ Option Shuffling : Yes Display Question Number : Yes Single Line Question Option : No Option Orientation : Vertical

Correct Marks : 4 Wrong Marks : 1

The metal that forms nitride by reacting directly with N_2 of air, is :

Options :

1. K
2. Rb
3. Cs
4. Li

Question Number : 44 Question Type : MCQ Option Shuffling : Yes Display Question Number : Yes Single Line Question Option : No Option Orientation : Vertical

Correct Marks : 4 Wrong Marks : 1

વહ ધાતુ જો હવા કી N_2 સે સીધે અભિક્રિયા કર નાઇટ્રાઇડ બનાતા હૈ, હૈ :

Options :

1. K
2. Rb
3. Cs
4. Li

Question Number : 44 Question Type : MCQ Option Shuffling : Yes Display Question Number : Yes Single Line Question Option : No Option Orientation : Vertical

Correct Marks : 4 Wrong Marks : 1

નીચે આપેલી ધાતુઓ પૈકી કઈ ધાતુ હવામાંના N_2 સાથે સીધી પ્રક્રિયા કરી નાઇટ્રાઇડ બનાવે છે?

Options :

1. K
2. Rb
3. Cs
4. Li

Question Number : 45 Question Type : MCQ Option Shuffling : Yes Display Question Number : Yes Single Line Question Option : No Option Orientation : Vertical

Correct Marks : 4 Wrong Marks : 1

Good reducing nature of H_3PO_2 is attributed to the presence of :

Options :

1. One P – H bond
2. Two P – H bonds
3. One P – OH bond
4. Two P – OH bonds

Question Number : 45 Question Type : MCQ Option Shuffling : Yes Display Question Number : Yes Single Line Question Option : No Option Orientation : Vertical

Correct Marks : 4 Wrong Marks : 1

H_3PO_2 की अच्छी अपचायक प्रवृत्ति किनकी उपस्थिति के कारण है?

Options :

1. एक P-H आबंध
2. दो P-H आबंध
3. एक P-OH आबंध
4. दो P-OH आबंध

Question Number : 45 Question Type : MCQ Option Shuffling : Yes Display Question Number : Yes Single Line Question Option : No Option Orientation : Vertical

Correct Marks : 4 Wrong Marks : 1

H_3PO_2 नो साथो रीड्यूसिंग स्वभाव नीचे आपेला पैकी कया अेकनी हाजरी ने आभारी छे?

Options :

1. अेक P-H अंध
2. बे P-H अंध
3. अेक P-OH अंध
4. बे P-OH अंध

Question Number : 46 Question Type : MCQ Option Shuffling : Yes Display Question Number : Yes Single Line Question Option : No Option Orientation : Vertical

Correct Marks : 4 Wrong Marks : 1

The transition element that has lowest enthalpy of atomisation, is :

Options :

1. V
2. Cu
3. Zn
4. Fe

Question Number : 46 Question Type : MCQ Option Shuffling : Yes Display Question Number : Yes Single Line Question Option : No Option Orientation : Vertical

Correct Marks : 4 Wrong Marks : 1

न्यूनतम कणन एन्थैल्पी रखने वाला संक्रमण तत्व है :

Options :

1. V
2. Cu
3. Zn
4. Fe

Question Number : 46 Question Type : MCQ Option Shuffling : Yes Display Question Number : Yes Single Line Question Option : No Option Orientation : Vertical

Correct Marks : 4 Wrong Marks : 1

નીચે આપેલા પૈકી કયા સંક્રાંતિ તત્વની પરમાણ્વીકરણ એન્ટાલ્પી સૌથી સાંછી છે?

Options :

1. V
2. Cu
3. Zn
4. Fe

Question Number : 47 Question Type : MCQ Option Shuffling : Yes Display Question Number : Yes Single Line Question Option : No Option Orientation : Vertical

Correct Marks : 4 Wrong Marks : 1

The complex that has highest crystal field splitting energy (Δ), is :

Options :

1. $K_2[CoCl_4]$
2. $K_3[Co(CN)_6]$
3. $[Co(NH_3)_5Cl]Cl_2$
4. $[Co(NH_3)_5(H_2O)]Cl_3$

Question Number : 47 Question Type : MCQ Option Shuffling : Yes Display Question Number : Yes Single Line Question Option : No Option Orientation : Vertical

Correct Marks : 4 Wrong Marks : 1

અધિકતમ ક્રિસ્ટલ ક્ષેત્ર વિપાટન ઊર્જા (Δ) રાખને વાલા સંકુલ હૈ :

Options :

1. $K_2[CoCl_4]$
2. $K_3[Co(CN)_6]$
3. $[Co(NH_3)_5Cl]Cl_2$
4. $[Co(NH_3)_5(H_2O)]Cl_3$

Question Number : 47 Question Type : MCQ Option Shuffling : Yes Display Question Number : Yes Single Line Question Option : No Option Orientation : Vertical

Correct Marks : 4 Wrong Marks : 1

નીચે આપેલા સંકિરણો પૈકી કયાની સ્ફટિક ક્ષેત્ર વિભાજન ઊર્જા (Δ) સૌથી વધુ છે?

Options :

1. $K_2[CoCl_4]$
2. $K_3[Co(CN)_6]$
3. $[Co(NH_3)_5Cl]Cl_2$
4. $[Co(NH_3)_5(H_2O)]Cl_3$

Question Number : 48 Question Type : MCQ Option Shuffling : Yes Display Question Number : Yes Single Line Question Option : No Option Orientation : Vertical

Correct Marks : 4 Wrong Marks : 1

એક ધાતુ આયન ' M^{3+} ' નો હોમોલેપ્ટિક અષ્ટફલકીય સંકિરણ તેના ત્રણ એકદંતીય લીગાન્ડ L_1 , L_2 અને L_3 અનુક્રમે લીલા, વાદળી અને લાલ વિસ્તારમાં તરંગલંબાઈ નું શોષણ કરે છે. તો આ લીગાન્ડની પ્રબળતા નો ચઢતો ક્રમ શોધો?

Options :

1. $L_1 < L_2 < L_3$
2. $L_3 < L_2 < L_1$
3. $L_2 < L_1 < L_3$
4. $L_3 < L_1 < L_2$

Question Number : 48 Question Type : MCQ Option Shuffling : Yes Display Question Number : Yes Single Line Question Option : No Option Orientation : Vertical

Correct Marks : 4 Wrong Marks : 1

Homoleptic octahedral complexes of a metal ion ' M^{3+} ' with three monodentate ligands L_1 , L_2 and L_3 absorb wavelengths in the region of green, blue and red respectively. The increasing order of the ligand strength is :

Options :

1. $L_1 < L_2 < L_3$

2. $L_3 < L_2 < L_1$

3. $L_2 < L_1 < L_3$

4. $L_3 < L_1 < L_2$

Question Number : 48 Question Type : MCQ Option Shuffling : Yes Display Question Number : Yes Single Line Question Option : No Option Orientation : Vertical

Correct Marks : 4 Wrong Marks : 1

तीन एकदंतुर लिगण्डों L_1 , L_2 तथा L_3 के साथ बने एक धातु आयन ' M^{3+} ' के होमोलेप्टिक अष्टफलक संकुल क्रमशः हरे, नीले एवं लाल क्षेत्र के तरंगदैर्घ्य अवशोषित करते हैं। लिगण्डों की प्रबलता का बढ़ता क्रम है :

Options :

1. $L_1 < L_2 < L_3$

2. $L_3 < L_2 < L_1$

3. $L_2 < L_1 < L_3$

4. $L_3 < L_1 < L_2$

Question Number : 49 Question Type : MCQ Option Shuffling : Yes Display Question Number : Yes Single Line Question Option : No Option Orientation : Vertical

Correct Marks : 4 Wrong Marks : 1

Which of the following conditions in drinking water causes methemoglobinemia ?

Options :

1. > 100 ppm of sulphate

2. > 50 ppm of lead

3. > 50 ppm of nitrate
4. > 50 ppm of chloride

Question Number : 49 Question Type : MCQ Option Shuffling : Yes Display Question Number : Yes Single Line Question Option : No Option Orientation : Vertical

Correct Marks : 4 Wrong Marks : 1

पीने के पानी से मेथेमोग्लोबिनेमिया होने के कारण की शर्त है :

Options :

1. > 100 ppm सल्फेट
2. > 50 ppm लेड
3. > 50 ppm नाइट्रेट
4. > 50 ppm क्लोराइड

Question Number : 49 Question Type : MCQ Option Shuffling : Yes Display Question Number : Yes Single Line Question Option : No Option Orientation : Vertical

Correct Marks : 4 Wrong Marks : 1

नीचे आपेसी पीवाना पाणीनी कई स्थितिमां मिथेमोग्लोबिनेमिया थाय छै ?

Options :

1. पाणी जेमां सल्फेट > 100 ppm
2. पाणी जेमां सीसुं (Lead) > 50 ppm
3. पाणी जेमां नाइट्रेट > 50 ppm
4. पाणी जेमां क्लोराइड > 50 ppm

Question Number : 50 Question Type : MCQ Option Shuffling : Yes Display Question Number : Yes Single Line Question Option : No Option Orientation : Vertical

Correct Marks : 4 Wrong Marks : 1

The pH of rain water, is approximately :

Options :

1. 7.0
2. 7.5

3. 6.5

4. 5.6

Question Number : 50 Question Type : MCQ Option Shuffling : Yes Display Question Number : Yes Single Line Question Option : No Option Orientation : Vertical

Correct Marks : 4 Wrong Marks : 1

वर्षा के पानी की pH लगभग है :

Options :

1. 7.0

2. 7.5

3. 6.5

4. 5.6

Question Number : 50 Question Type : MCQ Option Shuffling : Yes Display Question Number : Yes Single Line Question Option : No Option Orientation : Vertical

Correct Marks : 4 Wrong Marks : 1

વરસાદના પાણીની અંદાજિત pH શોધો ?

Options :

1. 7.0

2. 7.5

3. 6.5

4. 5.6

Question Number : 51 Question Type : MCQ Option Shuffling : Yes Display Question Number : Yes Single Line Question Option : No Option Orientation : Vertical

Correct Marks : 4 Wrong Marks : 1

For the following reaction, the mass of water produced from 445 g of $C_{57}H_{110}O_6$ is :

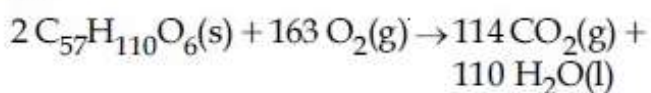

Options :

1. 445 g

2. 495 g

3. 490 g

4. 890 g

Question Number : 51 Question Type : MCQ Option Shuffling : Yes Display Question Number : Yes Single Line Question Option : No Option Orientation : Vertical

Correct Marks : 4 Wrong Marks : 1

निम्न अभिक्रिया के लिए, 445 g $C_{57}H_{110}O_6$ से उत्पादित जल का द्रव्यमान है :

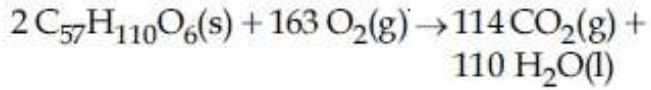

Options :

1. 445 g

2. 495 g

3. 490 g

4. 890 g

Question Number : 51 Question Type : MCQ Option Shuffling : Yes Display Question Number : Yes Single Line Question Option : No Option Orientation : Vertical

Correct Marks : 4 Wrong Marks : 1

आपेल प्रक्रिया में, 445 g $C_{57}H_{110}O_6$ में उत्पन्न होता पानी का द्रव्यमान क्या है ?

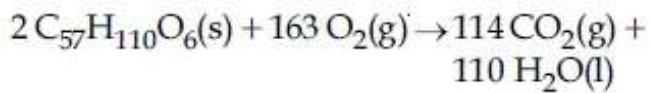

Options :

1. 445 g

2. 495 g

3. 490 g

4. 890 g

Question Number : 52 Question Type : MCQ Option Shuffling : Yes Display Question Number : Yes Single Line Question Option : No Option Orientation : Vertical

Correct Marks : 4 Wrong Marks : 1

At 100°C, copper (Cu) has FCC unit cell structure with cell edge length of $x \text{ \AA}$. What is the approximate density of Cu (in g cm^{-3}) at this temperature ?

[Atomic Mass of Cu = 63.55 u]

Options :

1. $\frac{105}{x^3}$

2. $\frac{211}{x^3}$

3. $\frac{422}{x^3}$

4. $\frac{205}{x^3}$

Question Number : 52 Question Type : MCQ Option Shuffling : Yes Display Question Number : Yes Single Line Question Option : No Option Orientation : Vertical

Correct Marks : 4 Wrong Marks : 1

100°C पर कापर (Cu), $x \text{ \AA}$ कोष्ठिका कोर की लम्बाई वाले FCC एकक कोष्ठिका संरचना रखता है। इस ताप पर Cu का घनत्व (g cm^{-3} में) लगभग होगा :

[Cu का परमाणु भार = 63.55 u]

Options :

1. $\frac{105}{x^3}$

2. $\frac{211}{x^3}$

3. $\frac{422}{x^3}$

4. $\frac{205}{x^3}$

Question Number : 52 Question Type : MCQ Option Shuffling : Yes Display Question Number : Yes Single Line Question Option : No Option Orientation : Vertical

Correct Marks : 4 Wrong Marks : 1

100°C એ કોપર (Cu), FCC એકમ કોષ બંધારણ માં છે. તેની કોષ ધાર લંબાઈ $x \text{ \AA}$ છે. તો આ તાપમાને Cu (g cm^{-3} માં) અંદાજિત ઘનતા શોધો?

[Cu નું પરમાણુ દળ = 63.55 u]

Options :

1. $\frac{105}{x^3}$

2. $\frac{211}{x^3}$

3. $\frac{422}{x^3}$

4. $\frac{205}{x^3}$

Question Number : 53 Question Type : MCQ Option Shuffling : Yes Display Question Number : Yes Single Line Question Option : No Option Orientation : Vertical

Correct Marks : 4 Wrong Marks : 1

Which of the following combination of statements is true regarding the interpretation of the atomic orbitals ?

- (a) An electron in an orbital of high angular momentum stays away from the nucleus than an electron in the orbital of lower angular momentum.
- (b) For a given value of the principal quantum number, the size of the orbit is inversely proportional to the azimuthal quantum number.
- (c) According to wave mechanics, the ground state angular momentum is equal to $\frac{h}{2\pi}$.
- (d) The plot of ψ Vs r for various azimuthal quantum numbers, shows peak shifting towards higher r value.

Options :

1. (a), (b)

2. (a), (c)

3. (b), (c)

4. (a), (d)

Question Number : 53 Question Type : MCQ Option Shuffling : Yes Display Question Number : Yes Single Line Question Option : No Option Orientation : Vertical

Correct Marks : 4 Wrong Marks : 1

परमाणु कक्षकों की व्याख्या से संबंधित कौन से संयुक्त कथन सत्य है?

- (a) कम कोणीय संवेग वाले कक्षक के इलेक्ट्रान की तुलना में अधिक कोणीय संवेग वाले कक्षक में इलेक्ट्रान नाभिक से दूर रहता है।
- (b) मुख्य क्वांटम संख्या के एक दिये मान के लिए कक्ष का आमाप बिगंशी क्वांटम संख्या के व्युत्क्रमानुपाती होता है।
- (c) तरंग यांत्रिकी के अनुसार निम्न अवस्था कोणीय संवेग $\frac{h}{2\pi}$ के बराबर होता है।
- (d) विभिन्न बिगंशी क्वांटम संख्याओं के लिए ψ Vs r का प्लॉट अधिक r मान की ओर पीक (शिखर) विस्थापित होना प्रदर्शित करता है।

Options :

1. (a), (b)

2. (a), (c)

3. (b), (c)

4. (a), (d)

Question Number : 53 Question Type : MCQ Option Shuffling : Yes Display Question Number : Yes Single Line Question Option : No Option Orientation : Vertical

Correct Marks : 4 Wrong Marks : 1

આણ્વિય કક્ષકો નાં અર્થઘટનના સંદર્ભમાં નીચે આપેલા વિધાનો પૈકી કયા બોડકા વિધાનો સાચા છે?

- (a) ઊંચું કોણીય વેગમાન ધરાવતી કક્ષકમાં રહેલો ઇલેક્ટ્રોન તેના કેન્દ્રથી, નીચું કોણીય વેગમાન ધરાવતી કક્ષકમાં રહેલા ઇલેક્ટ્રોન કરતા દૂર રહે છે.
- (b) આપેલા મુખ્ય ક્વોન્ટમ આંકના મુલ્ય માટે કક્ષકનું કદ તેના કોણીય વેગમાન ક્વોન્ટમ આંકના વ્યસ્ત પ્રમાણમાં ચલે છે.
- (c) ક્વોન્ટમ યાંત્રિકી મુજબ, ધરા અવસ્થા કોણીય વેગમાન $\frac{h}{2\pi}$ ને બરાબર હોય છે.
- (d) જુદા-જુદા કોણીય વેગમાન ક્વોન્ટમ આંક માટે V_s vs r નો આલેખ, દર્શાવે છે કે ટોચ વધુ r મુલ્ય તરફ ખસે છે.

Options :

1. (a), (b)
2. (a), (c)
3. (b), (c)
4. (a), (d)

Question Number : 54 Question Type : MCQ Option Shuffling : Yes Display Question Number : Yes Single Line Question Option : No Option Orientation : Vertical

Correct Marks : 4 Wrong Marks : 1

In which of the following processes, the bond order has increased and paramagnetic character has changed to diamagnetic ?

Options :

1. $\text{NO} \rightarrow \text{NO}^+$
2. $\text{O}_2 \rightarrow \text{O}_2^+$
3. $\text{O}_2 \rightarrow \text{O}_2^{2-}$
4. $\text{N}_2 \rightarrow \text{N}_2^+$

Question Number : 54 Question Type : MCQ Option Shuffling : Yes Display Question Number : Yes Single Line Question Option : No Option Orientation : Vertical

Correct Marks : 4 Wrong Marks : 1

नीचे दिए गए किस प्रक्रम में, आबंध कोटि बढ़ गयी और अनुचुंबकीय गुण प्रतिचुंबकीय में बदल गया ?

Options :

1. $\text{NO} \rightarrow \text{NO}^+$
2. $\text{O}_2 \rightarrow \text{O}_2^+$
3. $\text{O}_2 \rightarrow \text{O}_2^{2-}$
4. $\text{N}_2 \rightarrow \text{N}_2^+$

Question Number : 54 Question Type : MCQ Option Shuffling : Yes Display Question Number : Yes Single Line Question Option : No Option Orientation : Vertical

Correct Marks : 4 Wrong Marks : 1

नीचे आपेली प्रक्रिया पैकी कछ अेकमां अंध कमांक वधे छे अने अनुचुंबकीय गुणधर्मनुं प्रतियुंबकीय गुणधर्म मां इंपांतरित थाय छे ?

Options :

1. $\text{NO} \rightarrow \text{NO}^+$
2. $\text{O}_2 \rightarrow \text{O}_2^+$
3. $\text{O}_2 \rightarrow \text{O}_2^{2-}$
4. $\text{N}_2 \rightarrow \text{N}_2^+$

Question Number : 55 Question Type : MCQ Option Shuffling : Yes Display Question Number : Yes Single Line Question Option : No Option Orientation : Vertical

Correct Marks : 4 Wrong Marks : 1

The entropy change associated with the conversion of 1 kg of ice at 273 K to water vapours at 383 K is :

(Specific heat of water liquid and water vapour are $4.2 \text{ kJ K}^{-1} \text{ kg}^{-1}$ and $2.0 \text{ kJ K}^{-1} \text{ kg}^{-1}$; heat of liquid fusion and vapourisation of water are 334 kJ kg^{-1} and 2491 kJ kg^{-1} , respectively). ($\log 273 = 2.436$, $\log 373 = 2.572$, $\log 383 = 2.583$)

Options :

1. $2.64 \text{ kJ kg}^{-1} \text{ K}^{-1}$
2. $8.49 \text{ kJ kg}^{-1} \text{ K}^{-1}$

3. $7.90 \text{ kJ kg}^{-1} \text{ K}^{-1}$

4. $9.26 \text{ kJ kg}^{-1} \text{ K}^{-1}$

Question Number : 55 Question Type : MCQ Option Shuffling : Yes Display Question Number : Yes Single Line Question Option : No Option Orientation : Vertical

Correct Marks : 4 Wrong Marks : 1

273 K पर 1 kg बर्फ को 383 K के जल भाप में बदलने पर एंट्रॉपी में परिवर्तन होगा :

(जल तथा भाप की विशिष्ट ऊष्मा क्रमशः $4.2 \text{ kJ K}^{-1} \text{ kg}^{-1}$ एवं $2.0 \text{ kJ K}^{-1} \text{ kg}^{-1}$ हैं; संगलन की ऊष्मा तथा पानी की वाष्पीकरण ऊष्मा क्रमशः 334 kJ kg^{-1} एवं 2491 kJ kg^{-1} हैं) ($\log 273 = 2.436$, $\log 373 = 2.572$, $\log 383 = 2.583$)

Options :

1. $2.64 \text{ kJ kg}^{-1} \text{ K}^{-1}$

2. $8.49 \text{ kJ kg}^{-1} \text{ K}^{-1}$

3. $7.90 \text{ kJ kg}^{-1} \text{ K}^{-1}$

4. $9.26 \text{ kJ kg}^{-1} \text{ K}^{-1}$

Question Number : 55 Question Type : MCQ Option Shuffling : Yes Display Question Number : Yes Single Line Question Option : No Option Orientation : Vertical

Correct Marks : 4 Wrong Marks : 1

273 K એ 1 kg બરફ ને 383 K એ પાણીની વરાળ (બાષ્પ) માં રૂપાંતરિત કરવા માટે સંકળાયેલો એન્ટ્રોપી નો ફેરફાર શોધો?

(પાણી (પ્રવાહી) અને પાણીની વરાળ (બાષ્પ) ની વિશિષ્ટ ઊષ્મા $4.2 \text{ kJ K}^{-1} \text{ kg}^{-1}$ અને $2.0 \text{ kJ K}^{-1} \text{ kg}^{-1}$ પાણીની ગલન ઊષ્મા અને બાષ્પાયન ઊષ્મા અનુક્રમે 334 kJ kg^{-1} અને 2491 kJ kg^{-1}) ($\log 273 = 2.436$, $\log 373 = 2.572$, $\log 383 = 2.583$)

Options :

1. $2.64 \text{ kJ kg}^{-1} \text{ K}^{-1}$

2. $8.49 \text{ kJ kg}^{-1} \text{ K}^{-1}$

3. $7.90 \text{ kJ kg}^{-1} \text{ K}^{-1}$

4. $9.26 \text{ kJ kg}^{-1} \text{ K}^{-1}$

Question Number : 56 Question Type : MCQ Option Shuffling : Yes Display Question Number : Yes Single Line Question Option : No Option Orientation : Vertical

Correct Marks : 4 Wrong Marks : 1

A solution containing 62 g ethylene glycol in 250 g water is cooled to -10°C . If K_f for water is $1.86 \text{ K kg mol}^{-1}$, the amount of water (in g) separated as ice is :

Options :

1. 16
2. 32
3. 48
4. 64

Question Number : 56 Question Type : MCQ Option Shuffling : Yes Display Question Number : Yes Single Line Question Option : No Option Orientation : Vertical

Correct Marks : 4 Wrong Marks : 1

एक विलयन जिसमें 62 g इथिलीन ग्लाइकोल 250 g पानी में है, को -10°C तक ठंडा किया गया। यदि पानी का K_f $1.86 \text{ K kg mol}^{-1}$ हो, तब बर्फ के रूप में अलग हुए पानी की मात्रा (g में) है :

Options :

1. 16
2. 32
3. 48
4. 64

Question Number : 56 Question Type : MCQ Option Shuffling : Yes Display Question Number : Yes Single Line Question Option : No Option Orientation : Vertical

Correct Marks : 4 Wrong Marks : 1

250 g पाणी मां 62 g इथिलीन ग्लाइकोल धरावता द्रावण ने -10°C सुधी ठंडु करवा मां आव्युं. जे पाणीनो K_f $1.86 \text{ K kg mol}^{-1}$ होय, तो पाणीनो बरथो (g) मां जे बरइ स्वइपे छुटो पडे छे ते शोधो ?

Options :

1. 16
2. 32
3. 48
4. 64

Question Number : 57 Question Type : MCQ Option Shuffling : Yes Display Question Number : Yes Single Line Question Option : No Option Orientation : Vertical

Correct Marks : 4 Wrong Marks : 1

Consider the following reversible chemical reactions :

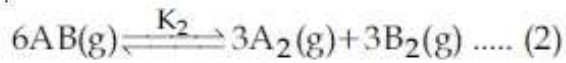
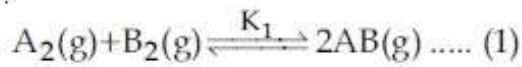

The relation between K_1 and K_2 is :

Options :

1. $K_2 = K_1^{-3}$
2. $K_2 = K_1^3$
3. $K_1 K_2 = 3$
4. $K_1 K_2 = \frac{1}{3}$

Question Number : 57 Question Type : MCQ Option Shuffling : Yes Display Question Number : Yes Single Line Question Option : No Option Orientation : Vertical

Correct Marks : 4 Wrong Marks : 1

निम्न उत्क्रमणीय अभिक्रियाओं पर विचार करें :

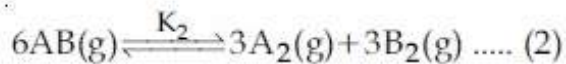
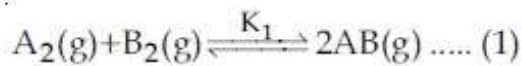

K_1 एवं K_2 के बीच संबंध है :

Options :

1. $K_2 = K_1^{-3}$
2. $K_2 = K_1^3$

3. $K_1K_2 = 3$

4. $K_1K_2 = \frac{1}{3}$

Question Number : 57 Question Type : MCQ Option Shuffling : Yes Display Question Number : Yes Single Line Question Option : No Option Orientation : Vertical

Correct Marks : 4 Wrong Marks : 1

નીચે આપેલી પ્રતિવ્રતી રાસાયણીક પ્રક્રિયા ધ્યાનમાં લો.

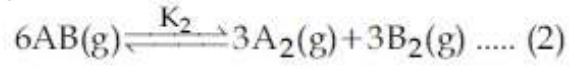
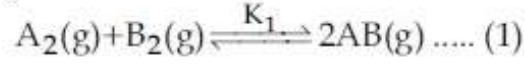

તો, K_1 અને K_2 ની વચ્ચેનો સંબંધ શોધો?

Options :

1. $K_2 = K_1^{-3}$

2. $K_2 = K_1^3$

3. $K_1K_2 = 3$

4. $K_1K_2 = \frac{1}{3}$

Question Number : 58 Question Type : MCQ Option Shuffling : Yes Display Question Number : Yes Single Line Question Option : No Option Orientation : Vertical

Correct Marks : 4 Wrong Marks : 1

If the standard electrode potential for a cell is 2 V at 300 K, the equilibrium constant (K) for the reaction

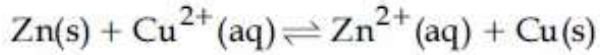

at 300 K is approximately

($R = 8 \text{ JK}^{-1}\text{mol}^{-1}$, $F = 96000 \text{ C mol}^{-1}$)

Options :

1. e^{-80}

2. e^{320}

3. e^{-160}

4. e^{160}

Question Number : 58 Question Type : MCQ Option Shuffling : Yes Display Question Number : Yes Single Line Question Option : No Option Orientation : Vertical

Correct Marks : 4 Wrong Marks : 1

एक सेल का 300 K पर मानक इलेक्ट्रोड विभव 2 V है। अभिक्रिया

$Zn(s) + Cu^{2+}(aq) \rightleftharpoons Zn^{2+}(aq) + Cu(s)$ के लिए 300 K ताप पर साम्यावस्था स्थिरांक (K) लगभग है :

($R = 8 \text{ JK}^{-1}\text{mol}^{-1}$, $F = 96000 \text{ C mol}^{-1}$)

Options :

1. e^{-80}
2. e^{320}
3. e^{-160}
4. e^{160}

Question Number : 58 Question Type : MCQ Option Shuffling : Yes Display Question Number : Yes Single Line Question Option : No Option Orientation : Vertical

Correct Marks : 4 Wrong Marks : 1

300 Kએ એક કોષનો પ્રમાણિત ઇલેક્ટ્રોડ પોટેન્શિયલ (વિભવ) 2 V છે. 300 K એ આપેલ પ્રક્રિયા માટે અંદાજિત સંતુલન અચળાંક (K) નીચેનામાંથી શોધો ?

$Zn(s) + Cu^{2+}(aq) \rightleftharpoons Zn^{2+}(aq) + Cu(s)$

($R = 8 \text{ JK}^{-1}\text{mol}^{-1}$, $F = 96000 \text{ C mol}^{-1}$)

Options :

1. e^{-80}
2. e^{320}
3. e^{-160}
4. e^{160}

Question Number : 59 Question Type : MCQ Option Shuffling : Yes Display Question Number : Yes Single Line Question Option : No Option Orientation : Vertical

Correct Marks : 4 Wrong Marks : 1

For the reaction, $2A + B \rightarrow \text{products}$, when the concentrations of A and B both were doubled, the rate of the reaction increased from $0.3 \text{ mol L}^{-1}\text{s}^{-1}$ to $2.4 \text{ mol L}^{-1}\text{s}^{-1}$. When the concentration of A alone is doubled, the rate increased from $0.3 \text{ mol L}^{-1}\text{s}^{-1}$ to $0.6 \text{ mol L}^{-1}\text{s}^{-1}$.

Which one of the following statements is correct ?

Options :

1. Order of the reaction with respect to B is 2
2. Total order of the reaction is 4
3. Order of the reaction with respect to A is 2
4. Order of the reaction with respect to B is 1

Question Number : 59 Question Type : MCQ Option Shuffling : Yes Display Question Number : Yes Single Line Question Option : No Option Orientation : Vertical

Correct Marks : 4 Wrong Marks : 1

अभिक्रिया, $2A + B \rightarrow \text{products}$ के लिए, जब A तथा B दोनों की सांद्रता दोगुनी की गई, तब अभिक्रिया की दर $0.3 \text{ mol L}^{-1}\text{s}^{-1}$ से बढ़कर $2.4 \text{ mol L}^{-1}\text{s}^{-1}$ हो गयी। जब केवल A की सांद्रता दोगुनी की गई तब दर $0.3 \text{ mol L}^{-1}\text{s}^{-1}$ से बढ़कर $0.6 \text{ mol L}^{-1}\text{s}^{-1}$ हो गई।

निम्न में कौन सा कथन सत्य है ?

Options :

1. अभिक्रिया की कोटि B के सापेक्ष में 2 है।
2. कुल अभिक्रिया की कोटि 4 है।
3. अभिक्रिया की कोटि A के सापेक्ष में 2 है।
4. अभिक्रिया की कोटि B के सापेक्ष में 1 है।

Question Number : 59 Question Type : MCQ Option Shuffling : Yes Display Question Number : Yes Single Line Question Option : No Option Orientation : Vertical

Correct Marks : 4 Wrong Marks : 1

આપેલ પ્રક્રિયા $2A + B \rightarrow$ નીપજો માટે, જ્યારે A અને B બંનેની સાંદ્રતા બમણી કરવામાં આવે ત્યારે પ્રક્રિયાનો દર $0.3 \text{ mol L}^{-1}\text{s}^{-1}$ થી વધી $2.4 \text{ mol L}^{-1}\text{s}^{-1}$ થાય છે. જ્યારે Aની એકલાની સાંદ્રતા બમણી કરવામાં આવે ત્યારે પ્રક્રિયા દર $0.3 \text{ mol L}^{-1}\text{s}^{-1}$ થી વધી $0.6 \text{ mol L}^{-1}\text{s}^{-1}$ થાય છે.

નીચે આપેલ વિધાના પૈકી કયું વિધાન સાચું છે?

Options :

1. B ના સંદર્ભમાં પ્રક્રિયાનો પ્રક્રિયા દર 2 છે.
2. પ્રક્રિયાનો કુલ પ્રક્રિયા દર 4 છે.
3. A ના સંદર્ભમાં પ્રક્રિયાનો પ્રક્રિયા દર 2 છે.
4. B ના સંદર્ભમાં પ્રક્રિયાનો પ્રક્રિયા દર 1 છે.

Question Number : 60 Question Type : MCQ Option Shuffling : Yes Display Question Number : Yes Single Line Question Option : No Option Orientation : Vertical

Correct Marks : 4 Wrong Marks : 1

For coagulation of arsenious sulphide sol, which one of the following salt solution will be most effective ?

Options :

1. AlCl_3
2. BaCl_2
3. NaCl
4. Na_3PO_4

Question Number : 60 Question Type : MCQ Option Shuffling : Yes Display Question Number : Yes Single Line Question Option : No Option Orientation : Vertical

Correct Marks : 4 Wrong Marks : 1

आर्सेनियस सल्फाइड का स्कंदन निम्न में से किस लवण के घोल से सबसे अधिक प्रभावकारी होगा ?

Options :

1. AlCl_3
2. BaCl_2

3. NaCl

4. Na₃PO₄

Question Number : 60 Question Type : MCQ Option Shuffling : Yes Display Question Number : Yes Single Line Question Option : No Option Orientation : Vertical

Correct Marks : 4 Wrong Marks : 1

નીચે આપેલા ક્ષારોના દ્રાવણ પૈકી કયું એક, આર્સેનિયસ સલ્ફાઇટ સોલ નાં સ્કંદન માટે સૌથી અસરકારક રહેશે?

Options :

1. AlCl₃

2. BaCl₂

3. NaCl

4. Na₃PO₄

Mathematics

Section Id :	416529120
Section Number :	3
Section type :	Online
Mandatory or Optional:	Mandatory
Number of Questions:	30
Number of Questions to be attempted:	30
Section Marks:	120
Display Number Panel:	Yes
Group All Questions:	No

Sub-Section Number:	1
Sub-Section Id:	416529129
Question Shuffling Allowed :	Yes

Question Number : 61 Question Type : MCQ Option Shuffling : Yes Display Question Number : Yes Single Line Question Option : No Option Orientation : Vertical

Correct Marks : 4 Wrong Marks : 1

Let $A = \{x \in \mathbb{R} : x \text{ is not a positive integer}\}$.

Define a function $f: A \rightarrow \mathbb{R}$ as $f(x) = \frac{2x}{x-1}$,

then f is :

Options :

1. not injective

2. injective but not surjective
3. surjective but not injective
4. neither injective nor surjective

Question Number : 61 Question Type : MCQ Option Shuffling : Yes Display Question Number : Yes Single Line Question Option : No Option Orientation : Vertical

Correct Marks : 4 Wrong Marks : 1

માના $A = \{x \in \mathbb{R} : x \text{ એક ધન પૂર્ણાંક નહીં છે}\}$ । એક ફલન $f: A \rightarrow \mathbb{R}$ નિમ્ન પ્રકાર સે પરિભાષિત છે :

$$f(x) = \frac{2x}{x-1}, \text{ તો } f \text{ એક :}$$

Options :

1. એકેકી ફલન નહીં છે ।
2. એકેકી છે, પરંતુ આચ્છાદક ફલન નહીં છે ।
3. આચ્છાદક છે, પરંતુ એકેકી ફલન નહીં છે ।
4. ન એકેકી છે ઓર ન આચ્છાદક ફલન છે ।

Question Number : 61 Question Type : MCQ Option Shuffling : Yes Display Question Number : Yes Single Line Question Option : No Option Orientation : Vertical

Correct Marks : 4 Wrong Marks : 1

ધારા કે $A = \{x \in \mathbb{R} : x \text{ સે ધનપૂર્ણાંક નથી}\}$ છે. વિધેય

$$f: A \rightarrow \mathbb{R} \text{ ને } f(x) = \frac{2x}{x-1} \text{ વડે વ્યાખ્યાયિત કરો.}$$

તો f એ _____ .

Options :

1. એક-એક નથી
2. એક-એક છે પણ વ્યાપ્ત નથી
3. વ્યાપ્ત છે પણ એક-એક નથી
4. એક-એક પણ નથી અને વ્યાપ્ત પણ નથી

Question Number : 62 Question Type : MCQ Option Shuffling : Yes Display Question Number : Yes Single Line Question Option : No Option Orientation : Vertical

Correct Marks : 4 Wrong Marks : 1

Let z_0 be a root of the quadratic equation,

$x^2 + x + 1 = 0$. If $z = 3 + 6iz_0^{81} - 3iz_0^{93}$, then

$\arg z$ is equal to :

Options :

1. $\frac{\pi}{4}$

2. $\frac{\pi}{6}$

3. $\frac{\pi}{3}$

4. 0

Question Number : 62 Question Type : MCQ Option Shuffling : Yes Display Question Number : Yes Single Line Question Option : No Option Orientation : Vertical

Correct Marks : 4 Wrong Marks : 1

माना कि द्विघातीय समीकरण $x^2 + x + 1 = 0$, का एक

मूल z_0 है। यदि $z = 3 + 6iz_0^{81} - 3iz_0^{93}$ है, तो

कोणांक z ($\arg z$) बराबर है :

Options :

1. $\frac{\pi}{4}$

2. $\frac{\pi}{6}$

3. $\frac{\pi}{3}$

4. 0

Question Number : 62 Question Type : MCQ Option Shuffling : Yes Display Question Number : Yes Single Line Question Option : No Option Orientation : Vertical

Correct Marks : 4 Wrong Marks : 1

ધારો કે z_0 એ દ્વિઘાત સમીકરણ $x^2 + x + 1 = 0$ નું એક

ખૂણ છે. જો $z = 3 + 6iz_0^{81} - 3iz_0^{93}$ હોય, તો

$\arg z = \underline{\hspace{2cm}}$.

Options :

1. $\frac{\pi}{4}$

2. $\frac{\pi}{6}$

3. $\frac{\pi}{3}$

4. 0

Question Number : 63 Question Type : MCQ Option Shuffling : Yes Display Question Number : Yes Single Line Question Option : No Option Orientation : Vertical

Correct Marks : 4 Wrong Marks : 1

The number of all possible positive integral values of α for which the roots of the quadratic equation, $6x^2 - 11x + \alpha = 0$ are rational numbers is :

Options :

1. 2

2. 3

3. 4

4. 5

Question Number : 63 Question Type : MCQ Option Shuffling : Yes Display Question Number : Yes Single Line Question Option : No Option Orientation : Vertical

Correct Marks : 4 Wrong Marks : 1

α के उन सभी संभावित धन पूर्णांक मानों की संख्या जिनके लिए द्विघातीय समीकरण $6x^2 - 11x + \alpha = 0$ के मूल परिमेय संख्याएँ हैं, है :

Options :

1. 2

2. 3

3. 4

4. 5

Question Number : 63 Question Type : MCQ Option Shuffling : Yes Display Question Number : Yes Single Line Question Option : No Option Orientation : Vertical

Correct Marks : 4 Wrong Marks : 1

द्विघात समीकरण $6x^2 - 11x + \alpha = 0$ નાં બીજ સંખ્ય સંખ્યાઓ થાય તેવી α ની શક્ય તમામ ધનપૂર્ણાંક કિંમતોની સંખ્યા _____ છે.

Options :

1. 2
2. 3
3. 4
4. 5

Question Number : 64 Question Type : MCQ Option Shuffling : Yes Display Question Number : Yes Single Line Question Option : No Option Orientation : Vertical

Correct Marks : 4 Wrong Marks : 1

If

$$A = \begin{bmatrix} e^t & e^{-t} \cos t & e^{-t} \sin t \\ e^t & -e^{-t} \cos t - e^{-t} \sin t & -e^{-t} \sin t + e^{-t} \cos t \\ e^t & 2e^{-t} \sin t & -2e^{-t} \cos t \end{bmatrix},$$

then A is :

Options :

1. invertible only if $t = \pi$.
2. invertible only if $t = \frac{\pi}{2}$.
3. invertible for all $t \in \mathbb{R}$.
4. not invertible for any $t \in \mathbb{R}$.

Question Number : 64 Question Type : MCQ Option Shuffling : Yes Display Question Number : Yes Single Line Question Option : No Option Orientation : Vertical

Correct Marks : 4 Wrong Marks : 1

यदि

$$A = \begin{bmatrix} e^t & e^{-t} \cos t & e^{-t} \sin t \\ e^t & -e^{-t} \cos t - e^{-t} \sin t & -e^{-t} \sin t + e^{-t} \cos t \\ e^t & 2e^{-t} \sin t & -2e^{-t} \cos t \end{bmatrix}$$

है, तो A :

Options :

व्युत्क्रमणीय (invertible) है, केवल तब, जब

1. $t = \pi$ है।

2. व्युत्क्रमणीय है, केवल तब, जब $t = \frac{\pi}{2}$ है।

3. सभी $t \in \mathbb{R}$ के लिए व्युत्क्रमणीय है।

4. किसी भी $t \in \mathbb{R}$ के लिए व्युत्क्रमणीय नहीं है।

Question Number : 64 Question Type : MCQ Option Shuffling : Yes Display Question Number : Yes Single Line Question Option : No Option Orientation : Vertical

Correct Marks : 4 Wrong Marks : 1

७१

$$A = \begin{bmatrix} e^t & e^{-t} \cos t & e^{-t} \sin t \\ e^t & -e^{-t} \cos t - e^{-t} \sin t & -e^{-t} \sin t + e^{-t} \cos t \\ e^t & 2e^{-t} \sin t & -2e^{-t} \cos t \end{bmatrix}$$

होय, तो A ने _____.

Options :

1. $t = \pi$ होय तो ७ व्यस्त भणे

2. $t = \frac{\pi}{2}$ होय तो ७ व्यस्त भणे

3. प्रत्येक $t \in \mathbb{R}$ भाटे व्यस्त भणे

4. कोईपण $t \in \mathbb{R}$ भाटे व्यस्त न भणे

Question Number : 65 Question Type : MCQ Option Shuffling : Yes Display Question Number : Yes Single Line Question Option : No Option Orientation : Vertical

Correct Marks : 4 Wrong Marks : 1

If the system of linear equations

$$x - 4y + 7z = g$$

$$3y - 5z = h$$

$$-2x + 5y - 9z = k$$

is consistent, then :

Options :

1. $2g + h + k = 0$

2. $g + 2h + k = 0$

3. $g + h + 2k = 0$

4. $g + h + k = 0$

Question Number : 65 Question Type : MCQ Option Shuffling : Yes Display Question Number : Yes Single Line Question Option : No Option Orientation : Vertical

Correct Marks : 4 Wrong Marks : 1

यदि रेखिक समीकरण निकाय

$$x - 4y + 7z = g$$

$$3y - 5z = h$$

$$-2x + 5y - 9z = k$$

संगत (consistent) है, तो :

Options :

1. $2g + h + k = 0$

2. $g + 2h + k = 0$

3. $g + h + 2k = 0$

4. $g + h + k = 0$

Question Number : 65 Question Type : MCQ Option Shuffling : Yes Display Question Number : Yes Single Line Question Option : No Option Orientation : Vertical

Correct Marks : 4 Wrong Marks : 1

बि सुरेष समीकरण संलति

$$x - 4y + 7z = g$$

$$3y - 5z = h$$

$$-2x + 5y - 9z = k$$

सुसंगत होय, तो _____ .

Options :

1. $2g + h + k = 0$

2. $g + 2h + k = 0$

3. $g + h + 2k = 0$

4. $g + h + k = 0$

Question Number : 66 Question Type : MCQ Option Shuffling : Yes Display Question Number : Yes Single Line Question Option : No Option Orientation : Vertical

Correct Marks : 4 Wrong Marks : 1

अंकों 0, 1, 3, 7, 9 के प्रयोग से (जहाँ अंकों को दोहराया जा सकता है) बनाई जा सकने वाली प्राकृत संख्याएँ जो 7,000 से कम हैं, की संख्या है :

Options :

1. 372
2. 375
3. 374
4. 250

Question Number : 66 Question Type : MCQ Option Shuffling : Yes Display Question Number : Yes Single Line Question Option : No Option Orientation : Vertical

Correct Marks : 4 Wrong Marks : 1

अंको 0, 1, 3, 7, 9 નો ઉપયોગ કરી, બનાવેલ 7,000 થી નાની પ્રાકૃતિક સંખ્યાઓની સંખ્યા _____ છે.
(અંકોનું પુનરાવર્તન કરવાની છૂટ છે.)

Options :

1. 372
2. 375
3. 374
4. 250

Question Number : 66 Question Type : MCQ Option Shuffling : Yes Display Question Number : Yes Single Line Question Option : No Option Orientation : Vertical

Correct Marks : 4 Wrong Marks : 1

The number of natural numbers less than 7,000 which can be formed by using the digits 0, 1, 3, 7, 9 (repetition of digits allowed) is equal to :

Options :

1. 372
2. 375
3. 374

Question Number : 67 Question Type : MCQ Option Shuffling : Yes Display Question Number : Yes Single Line Question Option : No Option Orientation : Vertical

Correct Marks : 4 Wrong Marks : 1

The coefficient of t^4 in the expansion of

$$\left(\frac{1-t^6}{1-t}\right)^3 \text{ is :}$$

Options :

1. 12
2. 10
3. 15
4. 14

Question Number : 67 Question Type : MCQ Option Shuffling : Yes Display Question Number : Yes Single Line Question Option : No Option Orientation : Vertical

Correct Marks : 4 Wrong Marks : 1

$$\left(\frac{1-t^6}{1-t}\right)^3 \text{ के प्रसार में } t^4 \text{ का गुणांक है :}$$

Options :

1. 12
2. 10
3. 15
4. 14

Question Number : 67 Question Type : MCQ Option Shuffling : Yes Display Question Number : Yes Single Line Question Option : No Option Orientation : Vertical

Correct Marks : 4 Wrong Marks : 1

$$\left(\frac{1-t^6}{1-t}\right)^3 \text{ ना विस्तारणमां } t^4 \text{ नो सहगुणक}$$

_____ છે.

Options :

1. 12

2. 10
3. 15
4. 14

Question Number : 68 Question Type : MCQ Option Shuffling : Yes Display Question Number : Yes Single Line Question Option : No Option Orientation : Vertical

Correct Marks : 4 Wrong Marks : 1

Let a, b and c be the 7th, 11th and 13th terms respectively of a non-constant A.P. If these are also the three consecutive terms of a

G.P., then $\frac{a}{c}$ is equal to :

Options :

1. 4
2. 2
3. $\frac{7}{13}$
4. $\frac{1}{2}$

Question Number : 68 Question Type : MCQ Option Shuffling : Yes Display Question Number : Yes Single Line Question Option : No Option Orientation : Vertical

Correct Marks : 4 Wrong Marks : 1

माना a, b तथा c एक समांतर श्रेणी (जो कि अचर समांतर श्रेणी नहीं है) के क्रमशः 7वें, 11वें तथा 13वें पद हैं। यदि ये एक गुणोत्तर श्रेणी के भी तीन क्रमागत

पद हैं तो $\frac{a}{c}$ बराबर है :

Options :

1. 4
2. 2
3. $\frac{7}{13}$
4. $\frac{1}{2}$

Question Number : 68 Question Type : MCQ Option Shuffling : Yes Display Question Number : Yes Single Line Question Option : No Option Orientation : Vertical

Correct Marks : 4 Wrong Marks : 1

ધારા કે a, b અને c એ એક અચળ ન હોય તેવી સમાંતર શ્રેણી (A.P.) નું અનુક્રમે 7મું, 11મું અને 13મું પદ છે. જો આ પદો એક સમગુણોત્તર શ્રેણી (G.P.) ના ત્રણ

ક્રમિક પદો પણ હોય, તો $\frac{a}{c} = \underline{\hspace{2cm}}$.

Options :

1. 4
2. 2
3. $\frac{7}{13}$
4. $\frac{1}{2}$

Question Number : 69 Question Type : MCQ Option Shuffling : Yes Display Question Number : Yes Single Line Question Option : No Option Orientation : Vertical

Correct Marks : 4 Wrong Marks : 1

The sum of the following series

$$1+6+\frac{9(1^2+2^2+3^2)}{7}+\frac{12(1^2+2^2+3^2+4^2)}{9}+\frac{15(1^2+2^2+\dots+5^2)}{11}+\dots \text{ up to 15 terms,}$$

is :

Options :

1. 7510
2. 7820
3. 7830
4. 7520

Question Number : 69 Question Type : MCQ Option Shuffling : Yes Display Question Number : Yes Single Line Question Option : No Option Orientation : Vertical

Correct Marks : 4 Wrong Marks : 1

निम्न श्रेणी

$$1+6+\frac{9(1^2+2^2+3^2)}{7}+\frac{12(1^2+2^2+3^2+4^2)}{9}$$
$$+\frac{15(1^2+2^2+\dots+5^2)}{11}+\dots$$

के प्रथम 15 पदों का योग है :

Options :

1. 7510
2. 7820
3. 7830
4. 7520

Question Number : 69 Question Type : MCQ Option Shuffling : Yes Display Question Number : Yes Single Line Question Option : No Option Orientation : Vertical

Correct Marks : 4 Wrong Marks : 1

નીચેની શ્રેણી

$$1+6+\frac{9(1^2+2^2+3^2)}{7}+\frac{12(1^2+2^2+3^2+4^2)}{9}$$
$$+\frac{15(1^2+2^2+\dots+5^2)}{11}+\dots$$

ના 15 પદો સુધીનો સરવાળો _____ છે.

Options :

1. 7510
2. 7820
3. 7830
4. 7520

Question Number : 70 Question Type : MCQ Option Shuffling : Yes Display Question Number : Yes Single Line Question Option : No Option Orientation : Vertical

Correct Marks : 4 Wrong Marks : 1

For each $x \in \mathbb{R}$, let $[x]$ be the greatest integer less than or equal to x . Then

$$\lim_{x \rightarrow 0^-} \frac{x([x]+|x|) \sin [x]}{|x|}$$
 is equal to :

Options :

1. $\sin 1$
2. 0
3. $-\sin 1$
4. 1

Question Number : 70 Question Type : MCQ Option Shuffling : Yes Display Question Number : Yes Single Line Question Option : No Option Orientation : Vertical

Correct Marks : 4 Wrong Marks : 1

सभी $x \in \mathbb{R}$ के लिए, माना $[x]$, एक महत्तम पूर्णांक है जो x के समान अथवा उससे कम है, तो

$\lim_{x \rightarrow 0^-} \frac{x([x]+|x|) \sin [x]}{|x|}$ बराबर है :

Options :

1. $\sin 1$
2. 0
3. $-\sin 1$
4. 1

Question Number : 70 Question Type : MCQ Option Shuffling : Yes Display Question Number : Yes Single Line Question Option : No Option Orientation : Vertical

Correct Marks : 4 Wrong Marks : 1

प्रत्येक $x \in \mathbb{R}$ माटे धारोके $[x]$ अे x थी नाना अथवा x ने समान तमाम पूर्णाकोमां सौथी मोटो पूर्णांक छे. तो

$\lim_{x \rightarrow 0^-} \frac{x([x]+|x|) \sin [x]}{|x|} = \dots\dots\dots$

Options :

1. $\sin 1$
2. 0
3. $-\sin 1$
4. 1

Question Number : 71 Question Type : MCQ Option Shuffling : Yes Display Question Number : Yes Single Line Question Option : No Option Orientation : Vertical

Correct Marks : 4 Wrong Marks : 1

If $x = 3 \tan t$ and $y = 3 \sec t$, then the value

of $\frac{d^2 y}{dx^2}$ at $t = \frac{\pi}{4}$, is :

Options :

1. $\frac{1}{6}$

2. $\frac{1}{6\sqrt{2}}$

3. $\frac{1}{3\sqrt{2}}$

4. $\frac{3}{2\sqrt{2}}$

Question Number : 71 Question Type : MCQ Option Shuffling : Yes Display Question Number : Yes Single Line Question Option : No Option Orientation : Vertical

Correct Marks : 4 Wrong Marks : 1

यदि $x = 3 \tan t$ तथा $y = 3 \sec t$ है, तो $t = \frac{\pi}{4}$ पर

$\frac{d^2 y}{dx^2}$ का मान है :

Options :

1. $\frac{1}{6}$

2. $\frac{1}{6\sqrt{2}}$

3. $\frac{1}{3\sqrt{2}}$

4. $\frac{3}{2\sqrt{2}}$

Question Number : 71 Question Type : MCQ Option Shuffling : Yes Display Question Number : Yes Single Line Question Option : No Option Orientation : Vertical

Correct Marks : 4 Wrong Marks : 1

જો $x=3 \tan t$ અને $y=3 \sec t$ હાય, તો $t=\frac{\pi}{4}$

આગળ $\frac{d^2y}{dx^2}$ ની કિંમત _____ છે.

Options :

1. $\frac{1}{6}$
2. $\frac{1}{6\sqrt{2}}$
3. $\frac{1}{3\sqrt{2}}$
4. $\frac{3}{2\sqrt{2}}$

Question Number : 72 Question Type : MCQ Option Shuffling : Yes Display Question Number : Yes Single Line Question Option : No Option Orientation : Vertical

Correct Marks : 4 Wrong Marks : 1

If both the roots of the quadratic equation $x^2 - mx + 4 = 0$ are real and distinct and they lie in the interval $[1, 5]$, then m lies in the interval :

Options :

1. $(-5, -4)$
2. $(3, 4)$
3. $(4, 5)$
4. $(5, 6)$

Question Number : 72 Question Type : MCQ Option Shuffling : Yes Display Question Number : Yes Single Line Question Option : No Option Orientation : Vertical

Correct Marks : 4 Wrong Marks : 1

यदि द्विघात समीकरण $x^2 - mx + 4 = 0$ के दोनों मूल वास्तविक तथा भिन्न हैं और वे अंतराल $[1, 5]$ में स्थित हैं, तो m जिस अंतराल में स्थित है, वह है :

Options :

1. $(-5, -4)$

2. (3, 4)

3. (4, 5)

4. (5, 6)

Question Number : 72 Question Type : MCQ Option Shuffling : Yes Display Question Number : Yes Single Line Question Option : No Option Orientation : Vertical

Correct Marks : 4 Wrong Marks : 1

જો દ્વિઘાત સમીકરણ $x^2 - mx + 4 = 0$ ના બંને બીજા વાસ્તવિક અને ભિન્ન હોય તથા તેઓ અંતરાલ $[1, 5]$ માં આવેલા હોય, તો m એ _____ અંતરાલમાં છે.

Options :

1. $(-5, -4)$

2. (3, 4)

3. (4, 5)

4. (5, 6)

Question Number : 73 Question Type : MCQ Option Shuffling : Yes Display Question Number : Yes Single Line Question Option : No Option Orientation : Vertical

Correct Marks : 4 Wrong Marks : 1

Let f be a differentiable function from \mathbb{R} to \mathbb{R} such that $|f(x) - f(y)| \leq 2|x - y|^{3/2}$, for all $x, y \in \mathbb{R}$. If $f(0) = 1$ then $\int_0^1 f^2(x) dx$ is

equal to :

Options :

1. 0

2. 1

3. $\frac{1}{2}$

4. 2

Question Number : 73 Question Type : MCQ Option Shuffling : Yes Display Question Number : Yes Single Line Question Option : No Option Orientation : Vertical

Correct Marks : 4 Wrong Marks : 1

माना $f: \mathbb{R} \rightarrow \mathbb{R}$ एक ऐसा अवकलनीय फलन है, कि

$$\text{सभी } x, y \in \mathbb{R} \text{ के लिए } |f(x) - f(y)| \leq 2|x - y|^{3/2}$$

है। यदि $f(0) = 1$ है, तो $\int_0^1 f^2(x) dx$ बराबर है :

Options :

1. 0
2. 1
3. $\frac{1}{2}$
4. 2

Question Number : 73 Question Type : MCQ Option Shuffling : Yes Display Question Number : Yes Single Line Question Option : No Option Orientation : Vertical

Correct Marks : 4 Wrong Marks : 1

धारो के f अ \mathbb{R} थी \mathbb{R} नुं अ \mathbb{R} विकलनीय विधेय छे के जेथी

$$\text{प्रत्येक } x, y \in \mathbb{R} \text{ मटे } |f(x) - f(y)| \leq 2|x - y|^{3/2} \text{ थाय.}$$

अ $f(0) = 1$ छेय, तो $\int_0^1 f^2(x) dx = \dots$

Options :

1. 0
2. 1
3. $\frac{1}{2}$
4. 2

Question Number : 74 Question Type : MCQ Option Shuffling : Yes Display Question Number : Yes Single Line Question Option : No Option Orientation : Vertical

Correct Marks : 4 Wrong Marks : 1

$$\text{If } f(x) = \int \frac{5x^8 + 7x^6}{(x^2 + 1 + 2x^7)^2} dx, (x \geq 0), \text{ and}$$

$f(0) = 0$, then the value of $f(1)$ is :

Options :

1. $-\frac{1}{2}$

2. $\frac{1}{4}$

3. $\frac{1}{2}$

4. $-\frac{1}{4}$

Question Number : 74 Question Type : MCQ Option Shuffling : Yes Display Question Number : Yes Single Line Question Option : No Option Orientation : Vertical

Correct Marks : 4 Wrong Marks : 1

यदि $f(x) = \int \frac{5x^8 + 7x^6}{(x^2 + 1 + 2x^7)^2} dx, (x \geq 0)$ तथा

$f(0) = 0$ है, तो $f(1)$ का मान है :

Options :

1. $-\frac{1}{2}$

2. $\frac{1}{4}$

3. $\frac{1}{2}$

4. $-\frac{1}{4}$

Question Number : 74 Question Type : MCQ Option Shuffling : Yes Display Question Number : Yes Single Line Question Option : No Option Orientation : Vertical

Correct Marks : 4 Wrong Marks : 1

यदि $f(x) = \int \frac{5x^8 + 7x^6}{(x^2 + 1 + 2x^7)^2} dx, (x \geq 0)$ अने

$f(0) = 0$ होय, तो $f(1)$ ची किंमत _____ छे.

Options :

1. $-\frac{1}{2}$

2. $\frac{1}{4}$

3. $\frac{1}{2}$

4. $-\frac{1}{4}$

Question Number : 75 Question Type : MCQ Option Shuffling : Yes Display Question Number : Yes Single Line Question Option : No Option Orientation : Vertical

Correct Marks : 4 Wrong Marks : 1

If $\int_0^{\pi/3} \frac{\tan \theta}{\sqrt{2k \sec \theta}} d\theta = 1 - \frac{1}{\sqrt{2}}$, ($k > 0$), then the

value of k is :

Options :

1. 2

2. 1

3. 4

4. $\frac{1}{2}$

Question Number : 75 Question Type : MCQ Option Shuffling : Yes Display Question Number : Yes Single Line Question Option : No Option Orientation : Vertical

Correct Marks : 4 Wrong Marks : 1

यदि $\int_0^{\pi/3} \frac{\tan \theta}{\sqrt{2k \sec \theta}} d\theta = 1 - \frac{1}{\sqrt{2}}$, ($k > 0$) है, तो k

का मान है :

Options :

1. 2

2. 1

3. 4

4. $\frac{1}{2}$

Question Number : 75 Question Type : MCQ Option Shuffling : Yes Display Question Number : Yes Single Line Question Option : No Option Orientation : Vertical

Correct Marks : 4 Wrong Marks : 1

$$\int_0^{\pi/3} \frac{\tan \theta}{\sqrt{2k \sec \theta}} d\theta = 1 - \frac{1}{\sqrt{2}}, \quad (k > 0) \text{ હોય, તો } k$$

ની કિંમત _____ છે.

Options :

1. 2
2. 1
3. 4
4. $\frac{1}{2}$

Question Number : 76 Question Type : MCQ Option Shuffling : Yes Display Question Number : Yes Single Line Question Option : No Option Orientation : Vertical

Correct Marks : 4 Wrong Marks : 1

The area of the region

$A = \{(x, y) : 0 \leq y \leq x|x| + 1 \text{ and } -1 \leq x \leq 1\}$ in sq. units, is :

Options :

1. $\frac{2}{3}$
2. $\frac{1}{3}$
3. $\frac{4}{3}$
4. 2

Question Number : 76 Question Type : MCQ Option Shuffling : Yes Display Question Number : Yes Single Line Question Option : No Option Orientation : Vertical

Correct Marks : 4 Wrong Marks : 1

क्षेत्र $A = \{(x, y) : 0 \leq y \leq x|x| + 1 \text{ तथा } -1 \leq x \leq 1\}$

का वर्ग इकाईयों में क्षेत्रफल है :

Options :

1. $\frac{2}{3}$

2. $\frac{1}{3}$

3. $\frac{4}{3}$

4. 2

Question Number : 76 Question Type : MCQ Option Shuffling : Yes Display Question Number : Yes Single Line Question Option : No Option Orientation : Vertical

Correct Marks : 4 Wrong Marks : 1

પ્રદેશ $A = \{(x, y) : 0 \leq y \leq x|x| + 1 \text{ અને } -1 \leq x \leq 1\}$
નું ક્ષેત્રફળ ચો. એકમમાં _____ છે.

Options :

1. $\frac{2}{3}$

2. $\frac{1}{3}$

3. $\frac{4}{3}$

4. 2

Question Number : 77 Question Type : MCQ Option Shuffling : Yes Display Question Number : Yes Single Line Question Option : No Option Orientation : Vertical

Correct Marks : 4 Wrong Marks : 1

Let $f: [0, 1] \rightarrow \mathbf{R}$ be such that $f(xy) = f(x).f(y)$,
for all $x, y \in [0, 1]$, and $f(0) \neq 0$. If $y = y(x)$
satisfies the differential equation,

$$\frac{dy}{dx} = f(x) \text{ with } y(0) = 1, \text{ then } y\left(\frac{1}{4}\right) + y\left(\frac{3}{4}\right)$$

is equal to :

Options :

1. 2

2. 3

3. 4

4. 5

Question Number : 77 Question Type : MCQ Option Shuffling : Yes Display Question Number : Yes Single Line Question Option : No Option Orientation : Vertical

Correct Marks : 4 Wrong Marks : 1

माना $f : [0, 1] \rightarrow \mathbb{R}$ इस प्रकार है कि सभी $x, y \in [0, 1]$ के लिए $f(xy) = f(x).f(y)$ है तथा $f(0) \neq 0$

है। यदि $y = y(x)$ अवकल समीकरण $\frac{dy}{dx} = f(x)$

को संतुष्ट करता है और $y(0) = 1$ है, तो

$y\left(\frac{1}{4}\right) + y\left(\frac{3}{4}\right)$ बराबर है :

Options :

1. 2
2. 3
3. 4
4. 5

Question Number : 77 Question Type : MCQ Option Shuffling : Yes Display Question Number : Yes Single Line Question Option : No Option Orientation : Vertical

Correct Marks : 4 Wrong Marks : 1

ધારોકે $f : [0, 1] \rightarrow \mathbb{R}$ એવું છે કે જેથી પ્રત્યેક $x, y \in [0, 1]$ માટે $f(xy) = f(x).f(y)$ અને $f(0) \neq 0$

થાય. જો $y = y(x)$ એ વિકલ સમીકરણ $\frac{dy}{dx} = f(x)$

ને સંતોષે, જ્યાં $y(0) = 1$ હોય, તો

$y\left(\frac{1}{4}\right) + y\left(\frac{3}{4}\right) = \underline{\hspace{2cm}}$

Options :

1. 2
2. 3
3. 4
4. 5

Question Number : 78 Question Type : MCQ Option Shuffling : Yes Display Question Number : Yes Single Line Question Option : No Option Orientation : Vertical

Correct Marks : 4 Wrong Marks : 1

Let S be the set of all triangles in the xy -plane, each having one vertex at the origin and the other two vertices lie on coordinate axes with integral coordinates. If each triangle in S has area 50 sq. units, then the number of elements in the set S is :

Options :

1. 9
2. 18
3. 36
4. 32

Question Number : 78 Question Type : MCQ Option Shuffling : Yes Display Question Number : Yes Single Line Question Option : No Option Orientation : Vertical

Correct Marks : 4 Wrong Marks : 1

माना S , xy -तल में स्थित ऐसी सभी त्रिभुजों का समुच्चय है जिनका एक शीर्ष मूल बिंदु पर है तथा दूसरे दो शीर्ष निर्देशांक अक्षों पर हैं तथा जिनके निर्देशांक पूर्णांकीय हैं। यदि S की प्रत्येक त्रिभुज का क्षेत्रफल 50 वर्ग इकाई है, तो समुच्चय S के अवयवों की संख्या है :

Options :

1. 9
2. 18
3. 36
4. 32

Question Number : 78 Question Type : MCQ Option Shuffling : Yes Display Question Number : Yes Single Line Question Option : No Option Orientation : Vertical

Correct Marks : 4 Wrong Marks : 1

જેનું એક શિરોબિંદુ ઉગમબિંદુ અને બીજા બે પૂર્ણાંક યામોવાળા શિરોબિંદુઓ યામાક્ષો પર આવેલા હોય તેવા xy -સમતલમાં આવેલા તમામ ત્રિકોણોનો ગણ ધારો કે S છે. જો S માંના પ્રત્યેક ત્રિકોણનું ક્ષેત્રફળ 50 થો. એકમ હોય, તો ગણ S ના સભ્યોની સંખ્યા _____ છે.

Options :

1. 9

2. 18

3. 36

4. 32

Question Number : 79 Question Type : MCQ Option Shuffling : Yes Display Question Number : Yes Single Line Question Option : No Option Orientation : Vertical

Correct Marks : 4 Wrong Marks : 1

Let the equations of two sides of a triangle be $3x - 2y + 6 = 0$ and $4x + 5y - 20 = 0$. If the orthocentre of this triangle is at $(1, 1)$, then the equation of its third side is :

Options :

1. $122y - 26x - 1675 = 0$

2. $26x - 122y - 1675 = 0$

3. $26x + 61y + 1675 = 0$

4. $122y + 26x + 1675 = 0$

Question Number : 79 Question Type : MCQ Option Shuffling : Yes Display Question Number : Yes Single Line Question Option : No Option Orientation : Vertical

Correct Marks : 4 Wrong Marks : 1

माना एक त्रिभुज की दो भुजाओं के समीकरण $3x - 2y + 6 = 0$ तथा $4x + 5y - 20 = 0$ हैं। यदि इस त्रिभुज का लंबकेंद्र $(1, 1)$ पर है, तो इसकी तीसरी भुजा का समीकरण है :

Options :

1. $122y - 26x - 1675 = 0$

2. $26x - 122y - 1675 = 0$

3. $26x + 61y + 1675 = 0$

4. $122y + 26x + 1675 = 0$

Question Number : 79 Question Type : MCQ Option Shuffling : Yes Display Question Number : Yes Single Line Question Option : No Option Orientation : Vertical

Correct Marks : 4 Wrong Marks : 1

ધારોકે એક ત્રિકોણની બે બાજુઓનાં સમીકરણ $3x - 2y + 6 = 0$ અને $4x + 5y - 20 = 0$ છે. જો આ ત્રિકોણનું લંબકેન્દ્ર $(1, 1)$ હોય, તો તેની ત્રીજી બાજુનું સમીકરણ _____ છે.

Options :

1. $122y - 26x - 1675 = 0$
2. $26x - 122y - 1675 = 0$
3. $26x + 61y + 1675 = 0$
4. $122y + 26x + 1675 = 0$

Question Number : 80 Question Type : MCQ Option Shuffling : Yes Display Question Number : Yes Single Line Question Option : No Option Orientation : Vertical

Correct Marks : 4 Wrong Marks : 1

If the circles $x^2 + y^2 - 16x - 20y + 164 = r^2$ and $(x - 4)^2 + (y - 7)^2 = 36$ intersect at two distinct points, then :

Options :

1. $1 < r < 11$
2. $0 < r < 1$
3. $r = 11$
4. $r > 11$

Question Number : 80 Question Type : MCQ Option Shuffling : Yes Display Question Number : Yes Single Line Question Option : No Option Orientation : Vertical

Correct Marks : 4 Wrong Marks : 1

यदि वृत्त $x^2 + y^2 - 16x - 20y + 164 = r^2$ तथा $(x - 4)^2 + (y - 7)^2 = 36$, दो भिन्न बिंदुओं पर काटते हैं, तो :

Options :

1. $1 < r < 11$
2. $0 < r < 1$
3. $r = 11$

4. $r > 11$

Question Number : 80 Question Type : MCQ Option Shuffling : Yes Display Question Number : Yes Single Line Question Option : No Option Orientation : Vertical

Correct Marks : 4 Wrong Marks : 1

જો વર્તુળો $x^2 + y^2 - 16x - 20y + 164 = r^2$ અને $(x - 4)^2 + (y - 7)^2 = 36$ બે ભિન્ન બિંદુઓ એ છેદે તો

Options :

1. $1 < r < 11$

2. $0 < r < 1$

3. $r = 11$

4. $r > 11$

Question Number : 81 Question Type : MCQ Option Shuffling : Yes Display Question Number : Yes Single Line Question Option : No Option Orientation : Vertical

Correct Marks : 4 Wrong Marks : 1

Let A(4, -4) and B(9, 6) be points on the parabola, $y^2 = 4x$. Let C be chosen on the arc AOB of the parabola, where O is the origin, such that the area of ΔACB is maximum. Then, the area (in sq.units) of ΔACB , is :

Options :

1. $31\frac{1}{4}$

2. $30\frac{1}{2}$

3. 32

4. $31\frac{3}{4}$

Question Number : 81 Question Type : MCQ Option Shuffling : Yes Display Question Number : Yes Single Line Question Option : No Option Orientation : Vertical

Correct Marks : 4 Wrong Marks : 1

माना $A(4, -4)$ तथा $B(9, 6)$ एक परवलय $y^2 = 4x$ पर स्थित दो बिंदु हैं। माना परवलय के चाप AOB (जहाँ O मूल बिंदु है) पर स्थित एक बिंदु C इस प्रकार चुना गया कि $\triangle ACB$ का क्षेत्रफल अधिकतम है, तो $\triangle ACB$ का क्षेत्रफल (वर्ग इकाईयों में) है :

Options :

1. $31\frac{1}{4}$

2. $30\frac{1}{2}$

3. 32

4. $31\frac{3}{4}$

Question Number : 81 Question Type : MCQ Option Shuffling : Yes Display Question Number : Yes Single Line Question Option : No Option Orientation : Vertical

Correct Marks : 4 Wrong Marks : 1

ધારોકે $A(4, -4)$ અને $B(9, 6)$ એ પરવલય $y^2 = 4x$ પરના બિંદુઓ છે. ચાપ AOB પર બિંદુ C એવી રીતે પસંદ કરવામાં આવે છે કે જેથી $\triangle ACB$ નું ક્ષેત્રફળ મહત્તમ થાય, જ્યાં O ઉગમબિંદુ છે. તો $\triangle ACB$ નું ક્ષેત્રફળ (ચો.એકમમાં) _____ છે.

Options :

1. $31\frac{1}{4}$

2. $30\frac{1}{2}$

3. 32

4. $31\frac{3}{4}$

Question Number : 82 Question Type : MCQ Option Shuffling : Yes Display Question Number : Yes Single Line Question Option : No Option Orientation : Vertical

Correct Marks : 4 Wrong Marks : 1

A hyperbola has its centre at the origin, passes through the point (4, 2) and has transverse axis of length 4 along the x -axis.

Then the eccentricity of the hyperbola is :

Options :

1. $\sqrt{3}$

2. $\frac{2}{\sqrt{3}}$

3. 2

4. $\frac{3}{2}$

Question Number : 82 Question Type : MCQ Option Shuffling : Yes Display Question Number : Yes Single Line Question Option : No Option Orientation : Vertical

Correct Marks : 4 Wrong Marks : 1

एक अतिपरवलय का केंद्र मूल बिंदु पर है, तथा यह बिंदु (4, 2) से होकर जाता है और इसका अनुप्रस्थ (transverse) अक्ष, x -अक्ष के अनुदिश है जिसकी लंबाई 4 है। तो इस अतिपरवलय की उत्केन्द्रता (eccentricity) है :

Options :

1. $\sqrt{3}$

2. $\frac{2}{\sqrt{3}}$

3. 2

4. $\frac{3}{2}$

Question Number : 82 Question Type : MCQ Option Shuffling : Yes Display Question Number : Yes Single Line Question Option : No Option Orientation : Vertical

Correct Marks : 4 Wrong Marks : 1

એક અતિવલયનું કેન્દ્ર ઉગમબિંદુ છે, તે બિંદુ (4, 2) માંથી પસાર થાય છે અને x -અક્ષ પરની તેના મુખ્ય અક્ષની લંબાઈ 4 છે. તો આ અતિવલયની ઉત્કેન્દ્રતા _____ છે.

Options :

1. $\sqrt{3}$

2. $\frac{2}{\sqrt{3}}$

3. 2

4. $\frac{3}{2}$

Question Number : 83 Question Type : MCQ Option Shuffling : Yes Display Question Number : Yes Single Line Question Option : No Option Orientation : Vertical

Correct Marks : 4 Wrong Marks : 1

If the lines $x = ay + b$, $z = cy + d$ and $x = a'z + b'$, $y = c'z + d'$ are perpendicular, then :

Options :

1. $ab' + bc' + 1 = 0$

2. $bb' + cc' + 1 = 0$

3. $aa' + c + c' = 0$

4. $cc' + a + a' = 0$

Question Number : 83 Question Type : MCQ Option Shuffling : Yes Display Question Number : Yes Single Line Question Option : No Option Orientation : Vertical

Correct Marks : 4 Wrong Marks : 1

यदि रेखाएँ $x = ay + b$, $z = cy + d$ तथा $x = a'z + b'$, $y = c'z + d'$ लंबवत हैं, तो :

Options :

1. $ab' + bc' + 1 = 0$

2. $bb' + cc' + 1 = 0$

3. $aa' + c + c' = 0$

4. $cc' + a + a' = 0$

Question Number : 83 Question Type : MCQ Option Shuffling : Yes Display Question Number : Yes Single Line Question Option : No Option Orientation : Vertical

Correct Marks : 4 Wrong Marks : 1

જો રેખાઓ $x = ay + b, z = cy + d$ અને $x = a'z + b', y = c'z + d'$ લંબ હાય, તો _____ .

Options :

1. $ab' + bc' + 1 = 0$
2. $bb' + cc' + 1 = 0$
3. $aa' + c + c' = 0$
4. $cc' + a + a' = 0$

Question Number : 84 Question Type : MCQ Option Shuffling : Yes Display Question Number : Yes Single Line Question Option : No Option Orientation : Vertical

Correct Marks : 4 Wrong Marks : 1

The equation of the plane containing the straight line $\frac{x}{2} = \frac{y}{3} = \frac{z}{4}$ and perpendicular to the plane containing the straight lines

$$\frac{x}{3} = \frac{y}{4} = \frac{z}{2} \text{ and } \frac{x}{4} = \frac{y}{2} = \frac{z}{3} \text{ is :}$$

Options :

1. $x + 2y - 2z = 0$
2. $3x + 2y - 3z = 0$
3. $x - 2y + z = 0$
4. $5x + 2y - 4z = 0$

Question Number : 84 Question Type : MCQ Option Shuffling : Yes Display Question Number : Yes Single Line Question Option : No Option Orientation : Vertical

Correct Marks : 4 Wrong Marks : 1

एक ऐसे समतल का समीकरण, जिस पर रेखा

$$\frac{x}{2} = \frac{y}{3} = \frac{z}{4} \text{ स्थित है तथा जो एक अन्य समतल}$$

जिसमें रेखाएँ $\frac{x}{3} = \frac{y}{4} = \frac{z}{2}$ तथा $\frac{x}{4} = \frac{y}{2} = \frac{z}{3}$ स्थित

हैं, के लंबवत है, है :

Options :

1. $x + 2y - 2z = 0$
2. $3x + 2y - 3z = 0$

3. $x - 2y + z = 0$

4. $5x + 2y - 4z = 0$

Question Number : 84 Question Type : MCQ Option Shuffling : Yes Display Question Number : Yes Single Line Question Option : No Option Orientation : Vertical

Correct Marks : 4 Wrong Marks : 1

રેખા $\frac{x}{2} = \frac{y}{3} = \frac{z}{4}$ ને સમાવતા તથા રેખાઓ

$\frac{x}{3} = \frac{y}{4} = \frac{z}{2}$ અને $\frac{x}{4} = \frac{y}{2} = \frac{z}{3}$ ને સમાવતા

સમતલને લંબ હોય તેવા સમતલનું સમીકરણ _____ છે.

Options :

1. $x + 2y - 2z = 0$

2. $3x + 2y - 3z = 0$

3. $x - 2y + z = 0$

4. $5x + 2y - 4z = 0$

Question Number : 85 Question Type : MCQ Option Shuffling : Yes Display Question Number : Yes Single Line Question Option : No Option Orientation : Vertical

Correct Marks : 4 Wrong Marks : 1

Let $\vec{a} = \hat{i} + \hat{j} + \sqrt{2}\hat{k}$, $\vec{b} = b_1\hat{i} + b_2\hat{j} + \sqrt{2}\hat{k}$

and $\vec{c} = 5\hat{i} + \hat{j} + \sqrt{2}\hat{k}$ be three vectors such

that the projection vector of \vec{b} on \vec{a} is \vec{a} .

If $\vec{a} + \vec{b}$ is perpendicular to \vec{c} , then $|\vec{b}|$ is equal to :

Options :

1. 6

2. 4

3. $\sqrt{22}$

4. $\sqrt{32}$

Question Number : 85 Question Type : MCQ Option Shuffling : Yes Display Question Number : Yes Single Line Question Option : No Option Orientation : Vertical

Correct Marks : 4 Wrong Marks : 1

$$\text{माना } \vec{a} = \hat{i} + \hat{j} + \sqrt{2}\hat{k}, \vec{b} = b_1\hat{i} + b_2\hat{j} + \sqrt{2}\hat{k}$$

तथा $\vec{c} = 5\hat{i} + \hat{j} + \sqrt{2}\hat{k}$ तीन ऐसे सदिश हैं कि

\vec{b} का \vec{a} पर प्रक्षेप सदिश, \vec{a} है। यदि $\vec{a} + \vec{b}$,

सदिश \vec{c} के लंबवत है, तो $|\vec{b}|$ बराबर है :

Options :

1. 6
2. 4
3. $\sqrt{22}$
4. $\sqrt{32}$

Question Number : 85 Question Type : MCQ Option Shuffling : Yes Display Question Number : Yes Single Line Question Option : No Option Orientation : Vertical

Correct Marks : 4 Wrong Marks : 1

$$\text{ધારો કે } \vec{a} = \hat{i} + \hat{j} + \sqrt{2}\hat{k},$$

$$\vec{b} = b_1\hat{i} + b_2\hat{j} + \sqrt{2}\hat{k} \text{ અને}$$

$\vec{c} = 5\hat{i} + \hat{j} + \sqrt{2}\hat{k}$ એ ત્રણ એવા સદિશો છે કે જેથી

\vec{b} નો \vec{a} પરનો પ્રક્ષેપ સદિશ \vec{a} છે. જો $\vec{a} + \vec{b}$ એ

\vec{c} ને લંબ હોય, તો $|\vec{b}| = \underline{\hspace{2cm}}$.

Options :

1. 6
2. 4
3. $\sqrt{22}$
4. $\sqrt{32}$

Question Number : 86 Question Type : MCQ Option Shuffling : Yes Display Question Number : Yes Single Line Question Option : No Option Orientation : Vertical

Correct Marks : 4 Wrong Marks : 1

A data consists of n observations :

x_1, x_2, \dots, x_n . If $\sum_{i=1}^n (x_i + 1)^2 = 9n$ and

$\sum_{i=1}^n (x_i - 1)^2 = 5n$, then the standard

deviation of this data is :

Options :

1. $\sqrt{7}$

2. $\sqrt{5}$

3. 5

4. 2

Question Number : 86 Question Type : MCQ Option Shuffling : Yes Display Question Number : Yes Single Line Question Option : No Option Orientation : Vertical

Correct Marks : 4 Wrong Marks : 1

आँकड़ों के एक समूह में n प्रेक्षण x_1, x_2, \dots, x_n हैं।

यदि $\sum_{i=1}^n (x_i + 1)^2 = 9n$ तथा $\sum_{i=1}^n (x_i - 1)^2 = 5n$

है, तो इन आँकड़ों का मानक विचलन है :

Options :

1. $\sqrt{7}$

2. $\sqrt{5}$

3. 5

4. 2

Question Number : 86 Question Type : MCQ Option Shuffling : Yes Display Question Number : Yes Single Line Question Option : No Option Orientation : Vertical

Correct Marks : 4 Wrong Marks : 1

એક માહિતીનાં n અવલોકનો x_1, x_2, \dots, x_n છે. જો

$$\sum_{i=1}^n (x_i + 1)^2 = 9n \quad \text{અને} \quad \sum_{i=1}^n (x_i - 1)^2 = 5n \quad \text{હોય,}$$

તો આ માહિતીનું પ્રમાણિત વિચલન _____ છે.

Options :

1. $\sqrt{7}$

2. $\sqrt{5}$

3. 5

4. 2

Question Number : 87 Question Type : MCQ Option Shuffling : Yes Display Question Number : Yes Single Line Question Option : No Option Orientation : Vertical

Correct Marks : 4 Wrong Marks : 1

एक कलश में 5 लाल तथा 2 हरी गेंदें हैं। इस कलश में से यादृच्छया एक गेंद निकाली गई। यदि निकाली गई गेंद हरी है, तो कलश में एक लाल गेंद डाली जाती है तथा यदि निकाली गई गेंद लाल है, तो कलश में एक हरी गेंद डाली जाती है, जबकि निकाली गई गेंद वापिस नहीं डाली जाती। अब इसमें से यादृच्छया एक दूसरी गेंद निकाली गई, तो इस दूसरी गेंद के लाल होने की प्रायिकता है :

Options :

1. $\frac{27}{49}$

2. $\frac{21}{49}$

3. $\frac{26}{49}$

4. $\frac{32}{49}$

Question Number : 87 Question Type : MCQ Option Shuffling : Yes Display Question Number : Yes Single Line Question Option : No Option Orientation : Vertical

Correct Marks : 4 Wrong Marks : 1

એક પાત્રમાં 5 લાલ અને 2 લીલા દડા છે. પાત્ર માંથી એક દડો યાદચ્છિક રીતે પસંદ કરવામાં આવે છે. જો પસંદ થયેલ દડો લીલો હોય, તો પાત્રમાં એક લાલ દડો ઉમેરવામાં આવે છે અને જો પસંદ થયેલ દડો લાલ હોય, તો પાત્રમાં એક લીલો દડો ઉમેરવામાં આવે છે; મૂળ દડો પાત્રમાં પાછો મૂકવામાં આવતો નથી. ત્યાર બાદ તેમાંથી એક એક બીજો દડો યાદચ્છિક રીતે પસંદ કરવામાં આવે છે. બીજો દડો લાલ હોય તેની સંભાવના _____ છે.

Options :

1. $\frac{27}{49}$

2. $\frac{21}{49}$

3. $\frac{26}{49}$

4. $\frac{32}{49}$

Question Number : 87 Question Type : MCQ Option Shuffling : Yes Display Question Number : Yes Single Line Question Option : No Option Orientation : Vertical

Correct Marks : 4 Wrong Marks : 1

An urn contains 5 red and 2 green balls. A ball is drawn at random from the urn. If the drawn ball is green, then a red ball is added to the urn and if the drawn ball is red, then a green ball is added to the urn ; the original ball is not returned to the urn. Now, a second ball is drawn at random from it. The probability that the second ball is red, is :

Options :

1. $\frac{27}{49}$

2. $\frac{21}{49}$

3. $\frac{26}{49}$

4. $\frac{32}{49}$

Question Number : 88 Question Type : MCQ Option Shuffling : Yes Display Question Number : Yes Single Line Question Option : No Option Orientation : Vertical

Correct Marks : 4 Wrong Marks : 1

If $0 \leq x < \frac{\pi}{2}$, then the number of values of x

for which $\sin x - \sin 2x + \sin 3x = 0$, is :

Options :

1. 3

2. 4

3. 2

4. 1

Question Number : 88 Question Type : MCQ Option Shuffling : Yes Display Question Number : Yes Single Line Question Option : No Option Orientation : Vertical

Correct Marks : 4 Wrong Marks : 1

यदि $0 \leq x < \frac{\pi}{2}$ है, तो x के उन मानों की संख्या

जिनके लिए $\sin x - \sin 2x + \sin 3x = 0$ है, है :

Options :

1. 3

2. 4

3. 2

4. 1

Question Number : 88 Question Type : MCQ Option Shuffling : Yes Display Question Number : Yes Single Line Question Option : No Option Orientation : Vertical

Correct Marks : 4 Wrong Marks : 1

જો $0 \leq x < \frac{\pi}{2}$ હોય, તો $\sin x - \sin 2x + \sin 3x = 0$

થાય તેવી x ની કિંમતોની સંખ્યા _____ છે.

Options :

1. 3

2. 4

3. 2

4. 1

Question Number : 89 Question Type : MCQ Option Shuffling : Yes Display Question Number : Yes Single Line Question Option : No Option Orientation : Vertical

Correct Marks : 4 Wrong Marks : 1

If $x = \sin^{-1}(\sin 10)$ and $y = \cos^{-1}(\cos 10)$,
then $y - x$ is equal to :

Options :

1. 0

2. π

3. 10

4. 7π

Question Number : 89 Question Type : MCQ Option Shuffling : Yes Display Question Number : Yes Single Line Question Option : No Option Orientation : Vertical

Correct Marks : 4 Wrong Marks : 1

यदि $x = \sin^{-1}(\sin 10)$ तथा $y = \cos^{-1}(\cos 10)$ है,
तो $y - x$ बराबर है :

Options :

1. 0

2. π

3. 10

4. 7π

Question Number : 89 Question Type : MCQ Option Shuffling : Yes Display Question Number : Yes Single Line Question Option : No Option Orientation : Vertical

Correct Marks : 4 Wrong Marks : 1

જો $x = \sin^{-1}(\sin 10)$ અને $y = \cos^{-1}(\cos 10)$ હોય,
તો $y - x =$ _____ .

Options :

1. 0

2. π

3. 10

4. 7π

Question Number : 90 Question Type : MCQ Option Shuffling : Yes Display Question Number : Yes Single Line Question Option : No Option Orientation : Vertical

Correct Marks : 4 Wrong Marks : 1

The logical statement

$[\sim(\sim p \vee q) \vee (p \wedge r)] \wedge (\sim q \wedge r)$
is equivalent to :

Options :

1. $\sim p \vee r$

2. $(p \wedge r) \wedge \sim q$

3. $(p \wedge \sim q) \vee r$

4. $(\sim p \wedge \sim q) \wedge r$

Question Number : 90 Question Type : MCQ Option Shuffling : Yes Display Question Number : Yes Single Line Question Option : No Option Orientation : Vertical

Correct Marks : 4 Wrong Marks : 1

तर्कसंगत कथन

$[\sim(\sim p \vee q) \vee (p \wedge r)] \wedge (\sim q \wedge r)$
निम्न में से किसके समतुल्य है?

Options :

1. $\sim p \vee r$

2. $(p \wedge r) \wedge \sim q$

3. $(p \wedge \sim q) \vee r$

4. $(\sim p \wedge \sim q) \wedge r$

Question Number : 90 Question Type : MCQ Option Shuffling : Yes Display Question Number : Yes Single Line Question Option : No Option Orientation : Vertical

Correct Marks : 4 Wrong Marks : 1

તાર્કિક વિધાન

$[\sim(\sim p \vee q) \vee (p \wedge r)] \wedge (\sim q \wedge r)$
એ _____ ને સમકક્ષ છે.

Options :

1. $\sim p \vee r$

2. $(p \wedge r) \wedge \sim q$

3. $(p \wedge \sim q) \vee r$

4. $(\sim p \wedge \sim q) \wedge r$